



Top Gun Barbecue Grill

BBQ19875CTG

United States and Canada

© 2023

Owner's Manual



www.calflamebbq.com

WARNING

If the information in this manual is not followed exactly, a fire or explosion may result causing property damage, personal injury or loss of life.

Do not store or use gasoline or other flammable vapors and liquids in the vicinity of this or any other appliance.

Do not store an LP cylinder not connected for use in the vicinity of this or any other appliance. A fire resulting in serious injury or death may occur.

If you are installing a natural gas grill, you are responsible for ensuring that the natural gas line installed is safe to use. LMS will not be held responsible for an improperly installed gas line.

DANGER

What To Do If You Smell Gas

- Shut off gas to the appliance.
- Extinguish any open flame.
- Open lid.
- If odor continues, keep away from the appliance and immediately call your gas supplier or your fire department.

CONTACT INFORMATION

For customer service, please contact your authorized dealer immediately. If you need additional information and/or assistance, please contact:

LMS Customer Service Department
1462 East Ninth Street
Pomona, CA 91766.

Toll Free: 1-800-225-7727
Fax: 1-909-629-3890

Copyright 2023 LMS. All rights reserved. Duplication without written consent is strictly prohibited. Cal Flame™ is registered trademark.

Due to continuous improvement programs, all models, operation, and/or specifications are subject to change without prior notice.

LTR50001121, Rev. L
12/30/2022

Safety Instructions	1
Placement and Location	1
Set-Up	1
Operation	1
Maintenance and Repair	2
Storage	2
Precautions Regarding Children	2
Proper Location of the Grill	3
Ensuring Proper Ventilation	3
Built-in Construction	4
Construction materials	4
Built-in Dimensions	4
Enclosure Ventilation	6
Gas and Electrical Supply Requirements	7
Gas Requirements	7
Electrical Supply Requirements	8
Installation and Connection	9
Connecting the Grill and Side Burner	9
Leak Testing Procedure	12
Attaching the Rotisserie Motor	13
Using Your Grill	14
Basic Grill Operation	14
Grill Controls	15
Lighting the Burners	16
Proper Burner Flame	17
Gas Cylinder Orientation	17
Heat Distribution on the Cooking Grates	18
Convection Fan	18
Burner Knob Lights	18
Using the Smoker Tray	19
Cooking with the Rotisserie	20
Optional Grill Accessories	21
Sear Zone Infrared Burner	21
Pizza Brick Tray	21
Charcoal Tray	22
Rotisserie Basket	22
Griddle Tray	23
Pull-Out Cutting Board	23
Cleaning and Maintenance	24
Stainless Steel Care and Cleaning	24
Rust Removal	25
Cleaning the Interior of Your Grill	25
Covering Your Grill	26
Seasonal Cleaning	27
Light Bulb Replacement	29
Appendix	30
Troubleshooting	30
Converting from LP to NG	33
Installing Sear Zone Burners	37
Replacement Parts	38
Limited Warranty	40

Safety Instructions

1

WARNING: Improper installation, adjustment, alteration, service or maintenance can cause injury or property damage. Read the installation, operating and maintenance instructions thoroughly before installing or servicing this equipment.

Read all instructions before you operate your grill.

Save these instructions!

Placement and Location

- **Cal Flame™ grills are designed for outdoor use only.**
- Never locate this appliance in an enclosed room, under a sealed overhead structure, or in any type of enclosed area such as a garage, shed, or breezeway. Keep clear of trees and shrubs.
- Do not place this grill under or near windows or vents that can be opened into your home.
- Cal Flame™ grills are not intended for installation in or on recreational vehicles or boats.
- Maintain sufficient distance as to not overheat any overhead combustible material such as a patio cover.
- The area surrounding your new grill should be kept clean and free from flammable liquids and other combustible materials such as mops, rags or brooms, as well as solvents, cleaning fluids, and gasoline.
- Do not use the grill, grill cabinet, or area surrounding the grill as a storage area for flammable or plastic items. Do not store the liquid propane (LP) cylinder in the vicinity of this or any other appliance when it is not being used.

Set-Up

- Before installing built in grills in enclosures, copy all product information such as model number, serial number and type of grill (e.g. natural gas or LP) and store information in a safe place. This information is located on a plate located behind

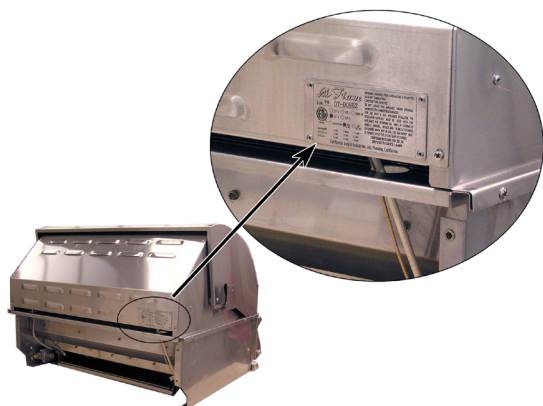

the grill and is visible when the hood is lowered or on the right side of the chassis. There is an area on the back cover of this manual where you can write down this information.

- We recommend that a licensed contractor install your Cal Flame™ grill. Installation must conform to local codes, or in the absence of local codes, with either the *National Fuel Gas Code*, ANSI Z223.1 / NFPA54, *Natural Gas and Propane Installation Code*, CSA B149.1, or *Propane Storage and Handling Code*, B149.2), as applicable.
- Your Cal Flame™ grill must be plugged into a permanent, grounded 110V outlet with a dedicated 15A GFCI breaker in accordance with local codes or the *National Electrical Code*, ANSI / NFPA 70, or the *Canadian Electrical Code*, CSA C22.1.
- Do not use an extension cord to supply power to your Cal Flame™ grill. Such use may result in fire, electrical shock or other personal injury. Do not install a fuse in the neutral or ground circuit. A fuse in the neutral or ground circuit may result in an electrical shock hazard. Do not ground this appliance to a gas supply pipe or hot water pipe. Keep any electrical supply cords and the fuel supply hose away from any heated surfaces.
- To prevent fire and smoke damage, remove all packaging material before operating grill.
- Before you start cooking, clean the entire grill thoroughly with hot, soapy water. This is necessary to remove residual solvents, oil and grease used in the manufacturing process. The grates should also be thoroughly cleaned in the same manner.

Operation

- Do not use grill for other than intended use.
- In the event that a burner goes out, turn burner knobs to the full OFF position, fully open the grill hood and let it air out. Do not attempt to use the grill until the gas has had time to dissipate.
- Never use the grill if the drip pan is not properly installed. Drip pan should be pushed all the way to the rack located just under the grill. Fire or explosion can result from an improperly installed drip pan.
- Keep all electrical supply cords and the rotisserie

- motor cord away from the heated areas of the grill.
- Never use the grill or side burner in windy conditions. If used in a consistently windy area a windbreak will be required. Always adhere to the specified clearances listed in this manual.
- Never line the grill or side burners with aluminum foil.
- When the unit is not in use, be sure to turn off the gas at the LP tank.
- Do not install or operate your grill unit in such a manner that the cross ventilation openings are blocked. Fresh air must be able to pass through installed vents to safeguard against residual gas accumulation. Failure to allow proper ventilation may cause fire or explosion.
- When handling LP gas line and connectors, do not allow them to come in contact with any metal surfaces of the cabinet. Do not drop LP connectors.
- Do not use fuel such as charcoal briquettes in gas grills. Use BBQ11859 Charcoal Tray.
- Gas sources to the grill and side burners must be regulated. Do not operate grill or side burners if regulators have been removed, fire or explosion can occur.
- Never leave the grill and side burners unattended when in use. When using pots and pans, boil-overs will cause smoking and greasy boil-overs may ignite.
- Always use the proper size pan. Select utensils with flat bottoms large enough to cover the burner. The use of under-sized utensils exposes the sides of the utensils to direct contact with a portion of the flame. This can scorch utensils and hamper cleanup. Excessive flames on large stainless steel pots can result in permanent discoloration. For best results, we recommend commercial quality aluminum pans and utensils.
- Always position handles of utensils so they do not extend over adjacent work areas or cooking areas. This reduces the risk of burns, ignition of flammable materials, and spillage due to accidental contact with the utensils.
- Do not use water on grease fires. Never pick up a flaming pan. Turn the appliance off and smother the flaming pan with a tight-fitting lid, a cookie sheet or a flat tray. For flaming grease outside of the pan, smother it with baking soda or use a dry chemical or foam-type fire extinguisher.
- Never allow clothing, pot holders or other flammable materials come in contact with or be close to any grate, burner or hot surface until it has fully cooled. Never wear loose fitting or hanging garments while using your grill. Fabric may ignite and result in personal injury.
- When using the grill, do not touch the grill rack, burner grate, or immediate surroundings as these areas become extremely hot and can cause burns. Use handles or knobs.
- Only use dry pot holders and do not use a towel or other bulky cloth in place of pot holders. Moist or damp pot holders used on hot surfaces can cause burns.
- Do not heat any unopened glass or metal container of food on the grill. Pressure may build up and cause the container to burst, possibly resulting in serious personal injury or damage to the grill.
- Do not reach over your grill or any other surfaces when hot or in use.

Maintenance and Repair

- Spiders and other insects can nest in the burners of the grill and block the gas and airflow to the burner ports. This creates a dangerous condition that can result in a fire behind the valve panel. Inspect and clean the burners periodically and follow the guidelines in the Cleaning and Maintenance section of this manual.

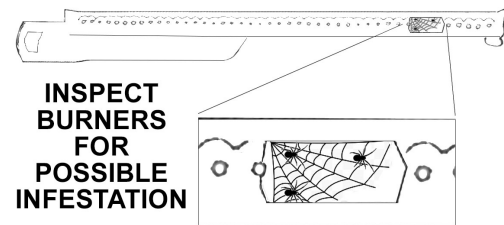

- Unless specifically recommended in this manual, do not repair or replace any part of the grill. A qualified technician should perform all service. Any repairs made by a non-LMS approved dealer technician will void your warranty.

Storage

- When your gas grill is not in use, turn off the gas at the supply cylinder.
- Storage of a grill indoors is permissible only if the supply cylinder is disconnected and removed.

Precautions Regarding Children

- Never leave children unattended in the area where the grill is being used. Close supervision of children is necessary when any appliance is used near children.
- Do not store items of interest to children around or below the grill.
- Never allow children to sit or stand on any part of the grill.

Proper Location of the Grill

Here are some general considerations when determining where to place your new barbecue island. Be certain that your installation will meet all city and local safety codes and requirements.

When planning your Cal Flame grill location, access to gas lines and 110V power supplies should be considered. If you are using natural gas, the location with the shortest gas line run is recommended. You may need a grounded, dedicated, 15A 110V GFCI power source for use of your appliances (e.g., lights, rotisserie, refrigerator, receptacles, etc.).

When determining a suitable location, consider factors such as exposure to wind, proximity to traffic paths, and windows that open into the home.

Locate the grill enclosure any place where there is adequate ventilation. The size and configuration of your house and yard will determine how you should locate your grill enclosure, but as a general rule, do not place it under or near windows that can be opened into your home. Ventilation is address in greater detail in the next section.

The sides, bottom and back of the grill enclosure should not be any closer than 24" to combustible construction.

To reduce the risk of personal injury caused by reaching over a hot appliance, avoid locating cabinet storage space directly above the outdoor grill.

Cal Flame grills are designed for outdoor use only.



Carbon Monoxide Hazard

This appliance can produce carbon monoxide which has no odor.



Using it in an enclosed space can kill you.

Never use this appliance in an enclosed space such as a camper, tent, car, or home.

Ensuring Proper Ventilation

Do not locate your barbecue island in an enclosed area, which is any covered area that is walled on two, three, or four sides. This includes areas or rooms such as a garage, shed, breezeway, patio, cabana, etc.

Although some enclosed areas may have windows, screens, or ventilation systems, they are nevertheless considered to be hazardous and may cause damage, injury, or death. Enclosed areas are NOT approved for a barbecue island.

- Solid foundation
- Open on three sides
- Minimum distance of six feet overhead from combustible material
- Overhead is not sealed
- Not placed near windows
- No overhead storage
- No combustible materials stored nearby

Do not locate your barbecue island under a sealed overhead structure. Acceptable overhead structures allow for airflow, such as screen or lattice.

You can install an awning over your barbecue island, provided you make sure it is high enough to prevent damage or fire. We recommend a minimum overhead distance of six feet from the top of the grill hood.

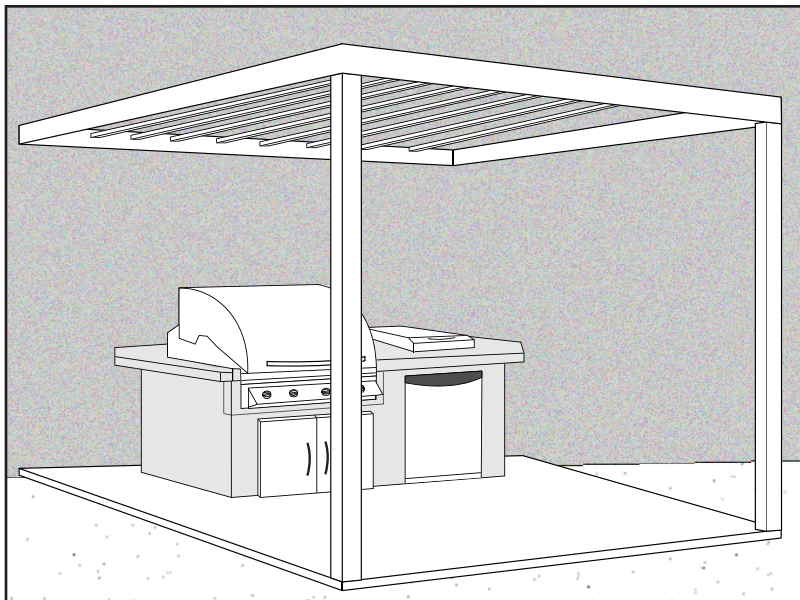

Built-in Construction

Note: The terms "built-in construction" and "grill enclosure" as used in these instructions refer to any method for installing a barbecue island for use. A barbecue island is both built-in constructions and a grill enclosure. Read these instruction before constructing your grill enclosure.

The Cal Flame convection grill is expected to be used with a Cal Flame barbecue island. If the convection grill is not placed in a Cal Flame barbecue island, it

must be used in a safe manner that will not void your warranty. If you plan to do this, use the information in this section on the construction and materials required for the grill enclosure and its proper location. Cal Flame wishes our customers to enjoy our products safely. We strongly recommend that grill owners hire a contractor to construct the built-in enclosure.

Failure to follow these instructions may result in voiding your warranty, property damage, injury, or death.

Construction materials

LMS will not be held responsible for property damage, injury, or death as a result of locating a grill enclosure in a non-approved location or using non-approved construction materials.



DO NOT use combustible materials for the built-in construction.



Acceptable building materials: Brick, cinder block, steel frame, hardiboard, granite, tile, glass brick, concrete, cement, stucco, stone.



Unacceptable building materials: Wood of any sort, laminate or synthetic materials, plastics, linoleum, fiberglass.

In addition, we do not recommend using materials that are susceptible to damage or decomposition by weather, such as dry wall or plaster.

Built-in Dimensions

Plan the installation so that the electrical connection, gas shut-off valve, and pressure regulator are accessible inside the base enclosure. The gas valve shall be readily accessible for hand operation. A door on the enclosure to gain access to the gas valve is acceptable, provided it is non-locking and can be opened without the use of tools.

The design of the outdoor cooking enclosure must allow the LP gas cylinder to be connected and disconnected and the connections inspected and tested.

There must be a minimum clearance of 2 inches (51mm) between the floor of the LP-gas cylinder enclosure and the ground.

The dimensions shown below are for Cal Flame appliances only.

Model	Width	Depth	Height
BBQ19875CTG - Top Gun Barbecue Grill	38 1/4"	22"	9 1/2"

Model	Width	Depth	Height
BBQ19954P - Deluxe Side by Side Burner	25 1/4"	13 1/4"	7 1/2"
BBQ19899P - Deluxe Double Side Burner	12 1/4"	22"	7 1/2"

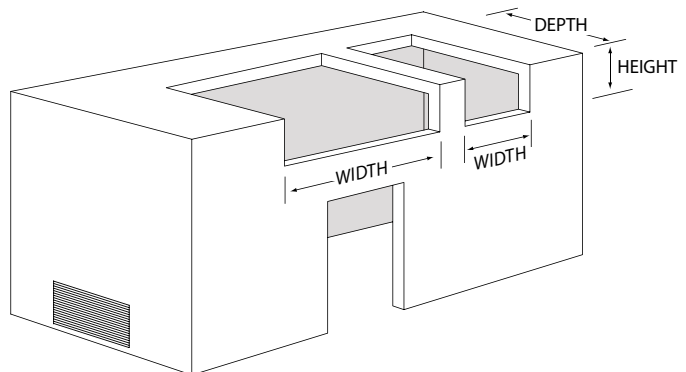

Built-in Dimensions cont.

The dimensions shown below are for Cal Flame appliances only.

Model	Description	Width	Depth
BBQ18953P	Side By Side Flat Burner	24 1/4"	19 3/4"
BBQ18852P	Single Flat Side Burner	11 1/2"	17 3/4"

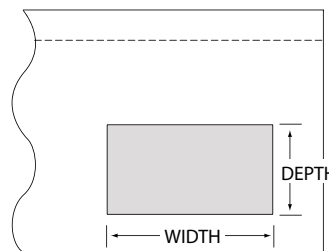
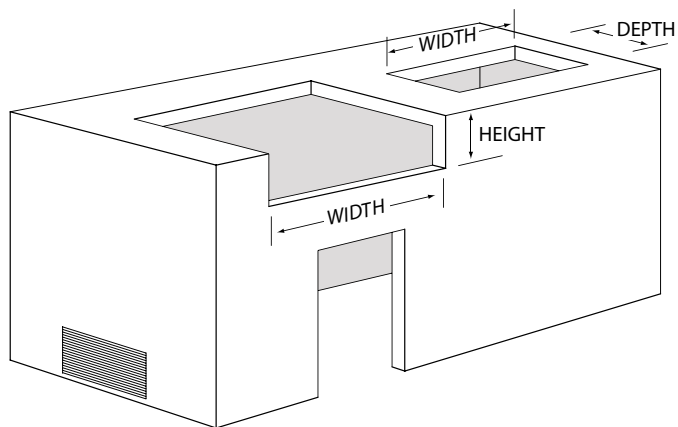

Top view of enclosure with back splash

The back edge of the grill must maintain a minimum clearance of 8" from non-combustible back splash materials.

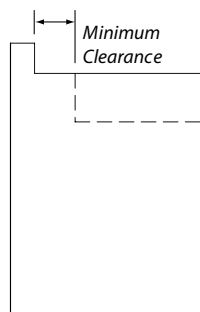

Side view of enclosure with back splash

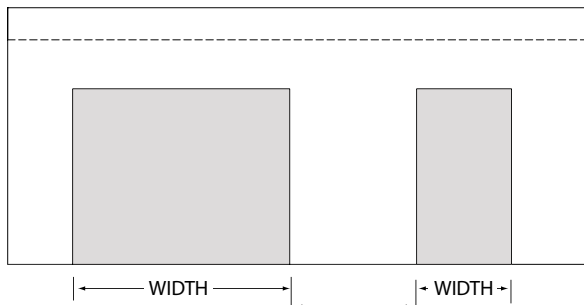

12" Minimum Distance Between Grill and Side Burner

Top view of enclosure with back splash

Enclosure Ventilation

Note: This section describes ventilation *within* the grill enclosure itself and not ventilation for the barbecue island.

For proper ventilation, the base structure must be constructed using one of two designs:

1 An enclosure with one side open

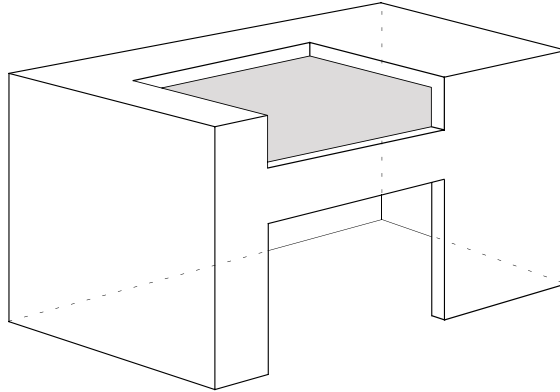

2 An enclosure having four sides, a top, and bottom

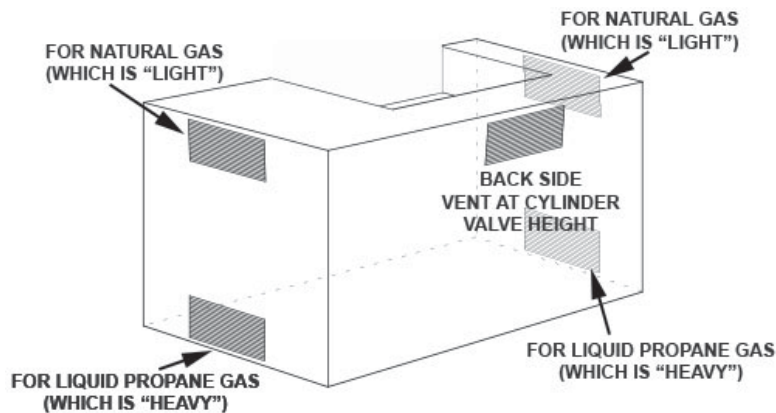

At least two ventilation openings at cylinder valve level shall be provided in the side wall, equally sized, spaced at 180 degrees and unobstructed. Each opening shall have a total free area of not less than 10 square inches (254 square mm).

Ventilation openings shall be provided at floor level and shall have a total free area of not less than 10 square inches (254 square mm). If the ventilation openings at floor level are in a side wall, there shall be at least two openings. The bottom of the openings shall be at floor level and the upper edge no more

than 5 inches (127mm) above the floor. The openings shall be equally sized, spaced, and unobstructed.

LP-gas cylinders should be ventilated by openings at the level of the cylinder valve and the floor level. The effectiveness of the openings, for purposes of ventilation, shall be determined with the LP-gas supply cylinder in place.

NOTE: Liquid Propane is heavy and settles to the floor
Natural Gas is light and will rise

Gas Requirements

Gas Requirements and Connection

IMPORTANT: The Cal Flame grill is manufactured to operate on liquid propane (LP). However, it can be converted to operate on natural gas (NG) by an authorized service technician.

This barbecue grill does not include the parts for converting to NG. The gas conversion kit can be ordered separately. The part number for the conversion kit is BBQ07101045. Grill conversion instructions can be found on page 33 and ordering information can be found in this manual on page 38.

Liquid Propane

Tank Requirements

For plumbed-in LP installation, use a convertible regulator and set it for LP gas.

Maximum line pressure for plumbed-in propane is 14" WC (3.5 kPa). Minimum line pressure for propane is 11" WC.

The grill must be used with the gas pressure regulator. The regulator will control and maintain a uniform gas pressure in the manifold. The burner orifices have been sized for the gas pressure delivered by the regulator.

WARNING: Attempting to operate the grill unit without the gas regulator installed could cause an explosion and possible death.

Cylinder Specification

The LP cylinder must be constructed and marked in accordance with the *Specifications for LP-Gas Cylinders* of the U.S. Department of Transportation or the National Standard of Canada, *CAN/CSA-B339, Cylinders, Spheres and Tubes for Transportation of Dangerous Goods; and Commission*, as applicable.

Any LP gas supply cylinder used with this grill must be approximately 12 inches in diameter and 18 inches high.

The maximum fuel capacity is 20 lbs. of propane, or 5 gallons. Full cylinder weight should be approximately 38 lbs. (43.7 lbs. nominal water capacity.) Never fill the cylinder beyond 80% full.

If you do not have an updated filler valve on your existing propane tank, you will need to purchase one at your local hardware store. Without it you will not be able to attach your tank to your grill or refill the tank at your local propane refill station.

Transporting and Storing LP Gas

Transport only one cylinder at a time. Ensure the cylinder is secured in an upright position with the control valve turned off and the dust cap in place. Store cylinders outdoors and out of reach of children. Do not store cylinders in a building, garage, or any other enclosed area.

Place the dust cap on the cylinder valve outlet whenever the cylinder is not in use. Only install the type of dust cap on the cylinder valve outlet that is provided with the cylinder valve. Other types of caps or plugs may result in leakage of propane.

Natural Gas

NG Service Installation and Connection

Natural gas installation of this appliance must conform with local codes or, in the absence of local codes, to the national fuel gas code, ANSI Z223.1a-2018. Installation in Canada must be in accordance with the standard CAN/CGA-B149.2, Propane Installation Code.

You do not need to hire a contractor to install your natural gas service, but you need to make sure you have all required permits and ensure the installation complies with State and local code. We recommend you hire a certified contractor if you do not wish to do the installation yourself.

The natural gas pipe from your house to the location of your barbecue island needs to be 3/4" and terminate with a shut-off valve with a 1/2" male fitting. Check with a contractor or your local inspector for requirements.

Always check the rating plate to make sure the gas supply you are hooking up to is the gas type the grill is manufactured for.

NG Regulator

The grill for use with natural gas comes equipped with its own regulator that **MUST NOT** be removed. If this regulator needs to be replaced, use only the type specified by for this appliance.

IMPORTANT: Never connect the grill to an unregulated gas supply.

Shut-off Valve

Ensure that the service supplying the grill is fitted with a shut off valve conveniently positioned near the grill and giving ease of access.

The grill must be isolated from the gas supply piping system by closing its individual manual shutoff valve during any pressure testing of the gas supply piping system at test pressures equal to or less than 0.5 psi (3.5 kPa).

Electrical Supply Requirements

You will need a dedicated 120V 10 amp grounded electrical service. The power supplied to your grill enclosure must be on a dedicated circuit with no other appliances or lights sharing the power.

You do not need to hire a contractor to install your electrical service, but you must ensure you have all required permits and the installation complies with State and local code. We recommend you hire a certified contractor if you do not wish to do the installation yourself.

If your dealer is not a certified contractor, you will need to hire a contractor for installation of your electrical service.

When installed in the United States, the electrical wiring must meet the requirements of National Electric Code, ANSI/NFPA 70-2018 and any applicable state or local codes. The electrical circuit must be installed

by an electrical contractor and approved by a local building / electrical inspector.

To determine the current, voltage, and wire size required for the island configuration to be connected, refer to the following:

- Wire size is determined by length of run from breaker box to the barbecue island and maximum current draw.
- We recommend copper wire with THHN insulation.
- All wiring must be copper to ensure adequate connections. Do not use aluminum wire.
- When NEC requires the use of wires larger than #6 (10mm²), install a junction box near the barbecue island and use #6 (10mm²) wire between the junction box and the grill enclosure.

Installation and Connection

Connecting the Grill and Side Burner

These instructions show you how to connect a grill only or a grill and side burner combination.

If you plan to convert to your grill from LP to NG, you need to do this before it is connected to a gas source. Grill conversion instructions can be found on page 33 and ordering information can be found in this manual on page 38. There are a few differences between connecting to LP and NG.

1. Place the Grill and Side Burner in the Cut-outs

You will need a second person to help you to avoid damaging the grill, the transformer, or your barbecue island.

Before installing a grill or side burner in any island or cut out, make sure that the opening is not bigger than the outside frame of the grill unit. The grill should rest on the lip of the frame. For drop-in accessories, adequate cross ventilation must be designed into enclosure to ensure the drop-in grill or side burner does not become overheated.

Pay careful attention to the location of gas lines. Gas lines should be routed away from sources of heat and should make as few bends as possible.

Check to see if gas line connections will be accessible when grill is installed.

- If gas line connections are not easily accessible when the grill is installed, support the grill above

counter level and attach the gas lines to the grill. When the gas connections are made, slide the grill into the cut out.

- If gas line connections are accessible when the grill is installed, slide the grill into the cut out and then attach the gas lines.

Be very careful not to kink gas lines when lowering the grill or side burner into the cut out.

Keep your fingers away from where the grill will be supported on counter. Your fingers could become trapped and serious injury could occur.

Check to make sure the grill is level and is supported around the entire outside edge. If the grill is not level or is unstable, use non-combustible shims under the outside lip to stabilize it.

Perform the leak test procedure as described earlier in this manual.

2. Connect the Gas Line to the Grill

Note: Make sure you have converted the grill for natural gas before connecting the gas line to the regulator. See page 33 for instructions on converting the grill from LP to NG.

Connecting the grill only

If you have a grill and side burner combination, go to step 3.b.

Slide the grill forward about six inches and connect the gas line to the grill using the appropriate connection for your gas type.

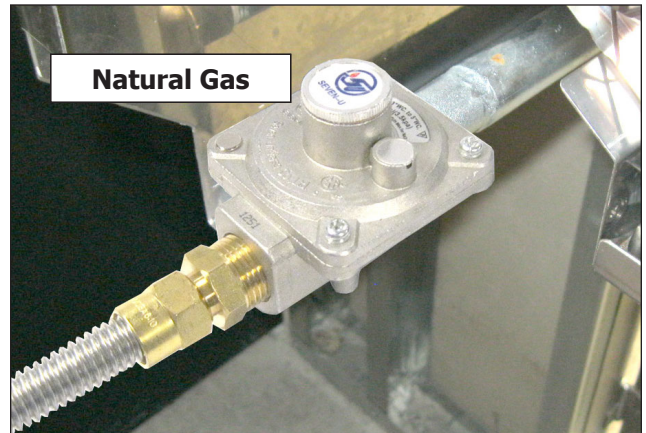
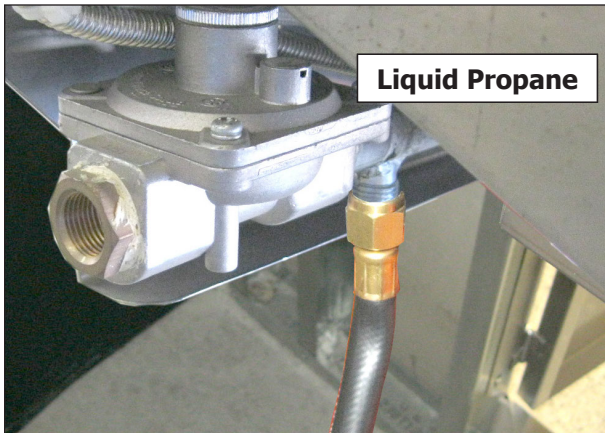
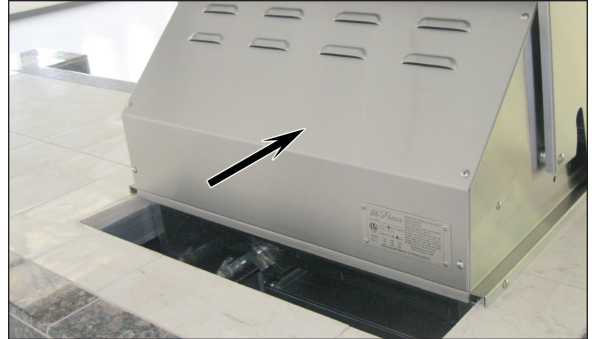

3. Connect the Gas Line to the Grill and Side Burner

Note: This is only necessary if you have a side burner.

a. Assemble the T Connection

Items required for connection (NOT included with your grill):

- One 3/8" T adapter
- One or two 1/2" to 3/8" flare reducers
- Two 3/8" flex lines
- LP gas line with regulator OR 3/8" NG flex line

Connect two 3/8" flex lines to the ends of the T connector that will connect with the grill and side burner. Connect either a third flex line (if you are using NG) or a LP gas line (if you are using LP) to the third end of the T connector as shown at left.

b. Connect to the grill

The gas manifold for the convection grill can be configured for both LP and NG. Make sure you connect to the correct fitting depending on your gas type. Connect to gas line to the grill as shown in step 3.a above.

c. Connect to the side burner

Connect the flex line from the T connector to the 1/2" to 3/8" flare reducer fitting on the side burner gas line. No regulator is required for either LP or NG.

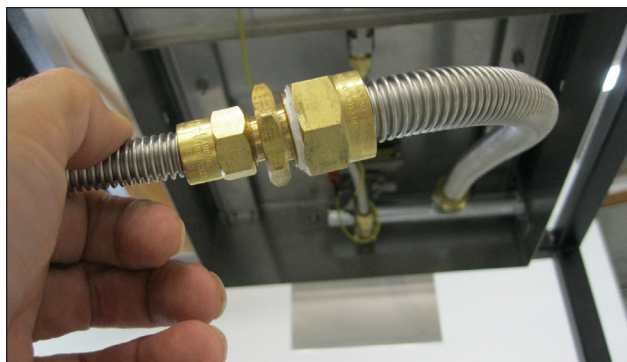
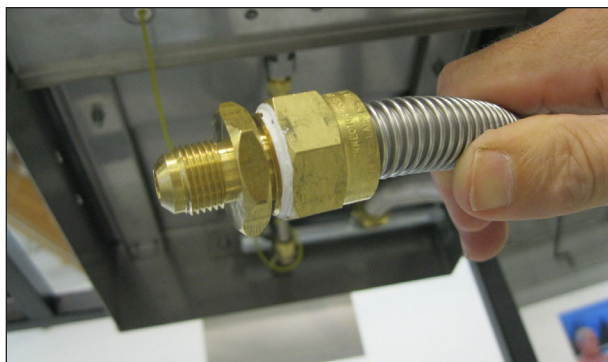
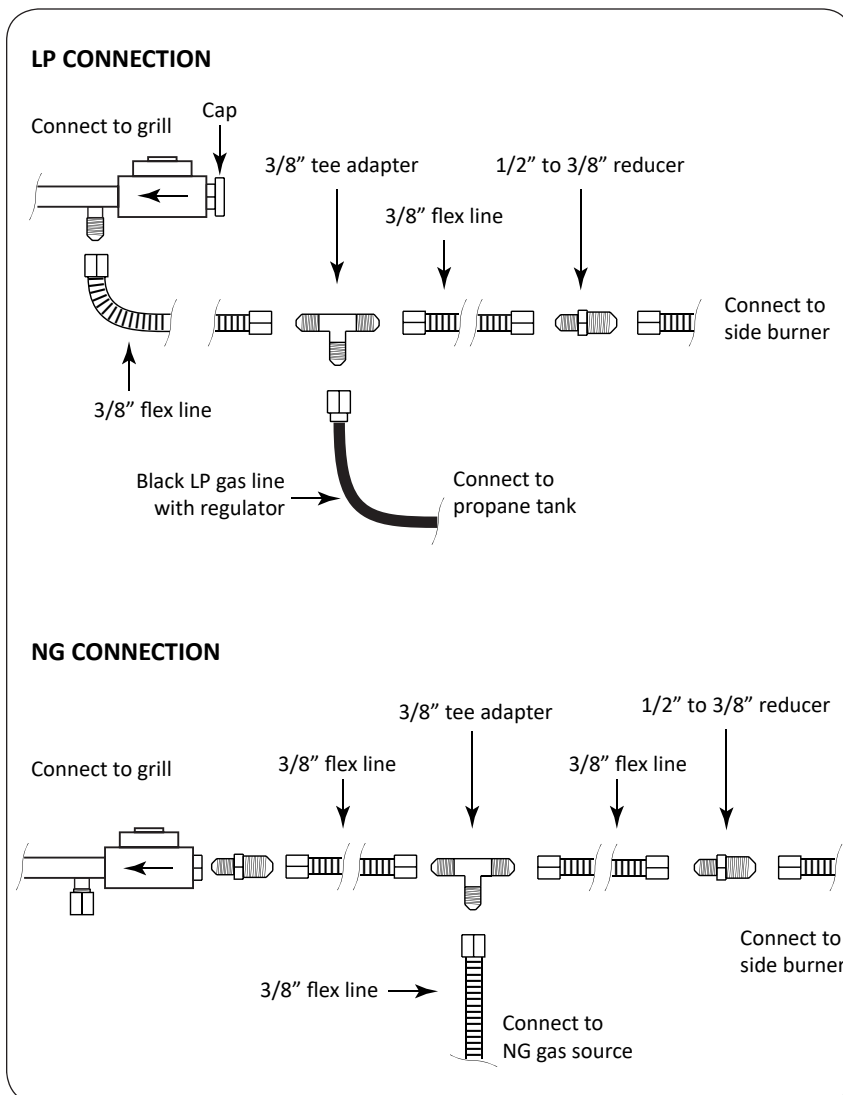

4. Connect to a Gas Source

Liquid Propane Connection

Use the pressure regulator and hose assembly supplied with the grill, or a regulator and hose assembly with the same specifications. Replacement LP regulator and hose must have a coupling nut that will connect to a QCC-1 cylinder valve on one end and a female fitting that will connect to a 3/8" tapered fitting on the grill manifold. See the figures below.

Connect the brass fitting to the manifold behind the grill. Do not use Teflon tape or plumber's dope. Do NOT remove the NG regulator from the manifold. Connect the coupling nut to the LP cylinder valve.

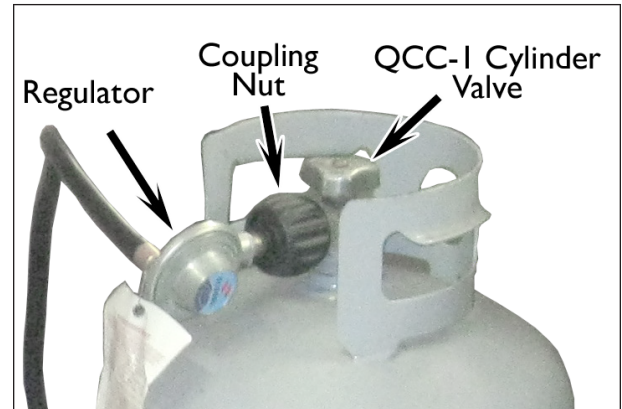

When you are finished connecting to the gas source, perform a leak test.

Natural Gas Connection

Connect the gas line to the NG stub-up inside the barbecue island. When you are finished connecting to the gas source, perform a leak test.

Leak Testing Procedure

Perform a leak test at least once a year whether the gas supply cylinder has been disconnected or not. In addition, whenever the gas cylinder is connected to the regulator or whenever any part of the gas system is disconnected or replaced, perform a leak test.

As a safety precaution, remember to always leak test your grill outdoors in a well-ventilated area. Never smoke or permit sources of ignition in the area while doing a leak test. Do not use a flame, such as a lighted match to test for leaks. Use a solution of soapy water.

1. Prepare a leak testing solution of soapy water by mixing in a spray bottle one part liquid soap to one part water.
2. Make sure all the control knobs are in the OFF position.
3. Turn on the gas.
 - a. On natural gas systems, turn the main feed valve to the grill.
 - b. On LP systems, turn the cylinder valve knob counter clockwise one turn to open.
4. Apply the leak-testing solution by spraying it on joints of the gas delivery system. Blowing

bubbles in the soap solution indicates that a leak is present.

5. Stop a leak by tightening the loose joint or by replacing the faulty part with a replacement part recommended by the manufacturer. Do not attempt to repair the cylinder valve if it is damaged. The cylinder must be replaced.
6. Turn all control knobs back to the full OFF position.

If you are unable to stop a leak:

1. Turn all control knobs back to the full OFF position.
2. Shut off the gas supply to the grill and release pressure in the hose and manifold by pushing in and turning any of the control valves one quarter turn counter-clockwise.
3. On LP systems, remove the cylinder from the grill.
4. Call an authorized gas appliance service technician or an LP gas dealer.

Do not use the appliance until the leak is corrected.

Attaching the Rotisserie Motor

Attach the two brackets to the sides of the grill, one on each side, using two screws as shown below.

Slide the rotis motor on one of the brackets as shown below. The rotis motor will work on either side of the grill.

When you are ready to use the rotisserie, connect the power cable to the rotisserie motor and plug it into the power outlet on the side of the front control panel.

See page 20 for instructions on cooking with the rotisserie.

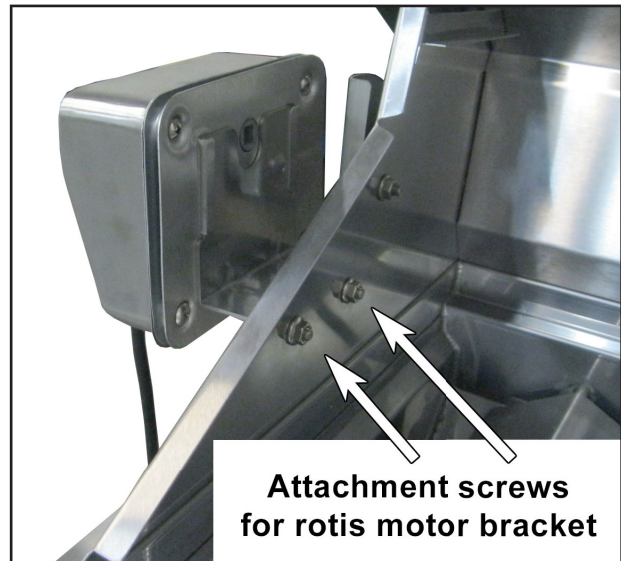

WARNING! Proposition 65 Warning: Handling the brass material on this product exposes you to lead, a chemical known to the State of California to cause cancer, birth defects or other reproductive harm. (Wash hands after handling this product.)

This product and the fuels used to operate this product (propane or natural gas), and the products of combustion of such fuels, can expose you to chemicals including Benzene, which is known to the state of California to cause cancer and birth defects or reproductive harm.

For more information go to www.P65Warnings.ca.gov.

Using Your Grill

Read all instructions before you operate your grill.

We recommend you wash your entire grill with soap and water prior to lighting it for the first time. Oils are used during the manufacturing process and some residual oil may still be on the stainless steel parts of your grill. Washing will reduce the possibility of discoloration. We also recommend you keep your grill covered when not in use. This will minimize the amount of dust and dirt that accumulates on your grill and extend the life of your grill.

Remember to use your Cal Flame grill safely by following these reminders:

- It is dangerous to use barbecue grills and side burners in any manner other than for what it is designed for.
- Do not use charcoal in a gas grill or side burner.
- Do not heat sealed containers such as cans or jars on grills or side burners. Explosion may result resulting in injury or death. Any sealed container, such as a pressure cooker, must have a properly operating pressure relieve valve to minimize explosion hazard.
- Never put combustible material such as paper, cloth, or flammable liquids on your grill at any time. Do not use grill, side shelves, cabinets, or any area around grill to store flammable materials.
- Never operate main burners and rear infrared convection burners at the same time. Excessive grill temperatures will result.

Basic Grill Operation

Before lighting, make sure all burner controls are off. Do not attempt to light the burners if the smell of gas is present. Check the connection with a soap and water solution after attaching the hose. For LP units, make sure there is gas in the tank and it is sitting upright. For natural gas units, make sure the shut off valve is on.

1. Make sure the drip tray is in place.
2. Light the grill burners using the instructions on the previous page.
3. Turn the control knob to HIGH and preheat the grill for 15 minutes. Close the top cover during the appliance preheat period.
4. Place the food on the grill and cook to desired completion. Adjust heat setting if necessary. You may set the control knob to any position between HIGH and LOW.
5. Allow the grill to cool and clean the drip tray after each use.

Do not leave the grill unattended while cooking.

Warning

NEVER cover the entire cooking or grill surface with griddles or pans. Overheating will occur and burners will not perform properly when combustion heat is trapped below the cooking surface.

CAUTION: NEVER spray water on a hot gas unit. This may damage porcelain or cast iron components.

Grill Controls

The controls shown below are for Cal Flame drop-in grills. Familiarize yourself with these controls before lighting your grill.

Burner Controls



The control panel for the Top Gun grill has a total of eight knobs, which includes five grill burners, two infrared back burners, and a smoker tray burner shown in the figure below.

All of the burner knobs have variable heat control and can be set to burn at high or low heat, depending on your preference.

See the next page for instructions on lighting the burners.

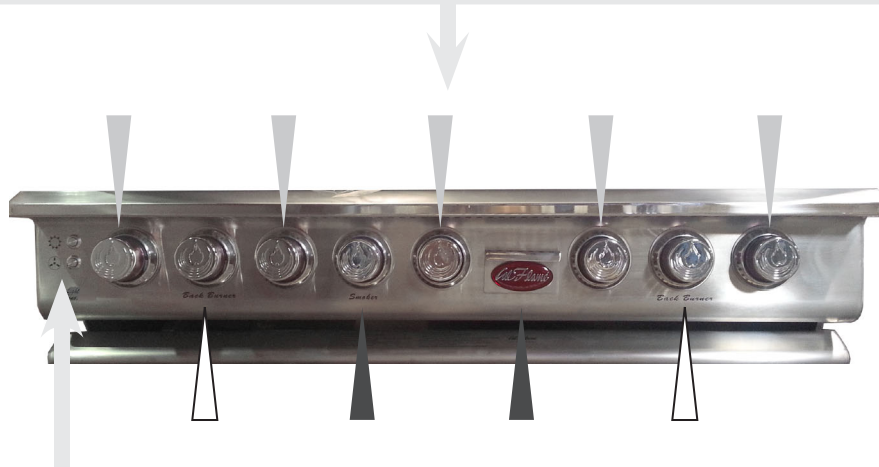
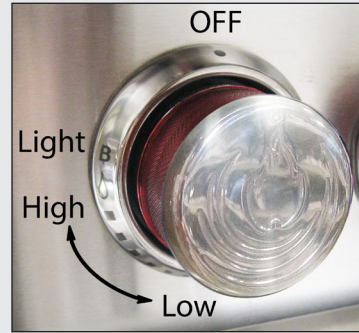
For a full description of grilling with the smoker tray, see page 19.



-  Grill burner knobs
-  Infrared back burner knobs
-  Smoker tray burner knob and smoker tray

Light and Fan Buttons

Two buttons controlling the fan and halogen lights are located on the control panel at the front lower left side.



Knob Light Button

This button controls the lights that illuminate the burner knobs on the control panel.

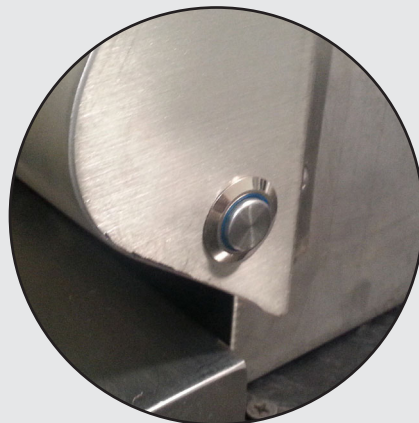

Lighting the Burners

Each time you light the grill, check the following:

- Inspect the hose before using the grill. If there is excessive abrasion or wear, or if the hose is cut, it must be replaced prior to using the grill. If you need a replacement hose, contact your Cal Flame dealer.
- Ensure the area around the barbecue is clear of flammable substances such as gasoline, yard debris, wood, etc.
- Ensure there is no blockage of the airflow through the vent space located below the face of the unit.
- When using propane gas, keep the special ventilation openings in the enclosure free and clear of debris.
- If connected to a propane cylinder, carefully inspect the rubber hose attached to the regulator before each use.
- Ensure the propane cylinder, regulator, and rubber hose are installed in a location not subject to heating above 125° F (51° C).
- Ensure the burner flames burn evenly along both sides of each burner with a steady flame (mostly blue with yellow tipping). If burner flames are not normal, check the orifice and burner for insects or insect nests.
- Ensure the in-line gas valve or gas cylinder valve is always shut OFF when the barbecue is not in use.
- Do not operate the side burner with its cover closed or the back burner with its cover installed.

Electronically Lighting the Burners

1. Open the hood.
2. Keep your face as far away from the burners as possible.
3. Press and rotate the burner knob counter clockwise past the light position to HIGH. You will hear a loud click as the electronic lighter produces a spark.
4. Listen for the sound of the gas igniting. If the burner does not light on the first try, repeat immediately.
5. If the burner does not light after three attempts, turn the control knobs to the OFF position. Wait five minutes until the gas clears before attempting to light it again.
6. Repeat the procedure or try the manual lighting procedure.
7. Upon successful lighting, repeat the process on the other burners you wish to light.
8. To shut off the burners, rotate the knob and turn to OFF. It is normal to hear a popping sound when the burners are turned off.

Manually Lighting the Burners

WARNING: Do not use standard matches or cigarette lighters to perform match lighting procedures. Serious burns can occur and lighters can explode.

1. Open the hood.
2. If you have just attempted to light the burner, allow five minutes for any accumulated gas to dissipate.
3. Slide out the drip tray from the grill.
4. Keep your face as far away from the burners as possible.
5. Light and insert a long stem match, holding it near the burner ports.
6. Push in and turn the control knob just past the LIGHT position to HIGH.
7. Listen for the sound of the gas igniting. If the burner does not light after five seconds, turn the control knobs to the OFF position. Wait five minutes until the gas clears before attempting to light it again.
8. If the burner does not light after several attempts see Troubleshooting Guide in the back of this manual.

Proper Burner Flame

Flame Color and Height

The burner flame has been set in the factory and should already be adjusted for proper height and intensity. Periodically, you may wish to check each burner's flame for color, height, and intensity. Remove the grill rack and the flame tamer over the burner you want to inspect.

When the burner is operating properly, the flame will appear between light to dark blue, with occasional yellow bursts (due to impurities in propane -- this is normal).

When the burner is set on high, the flame spread out about 1/2" away from the side of the burner. (See top figure at right.)

When the burner is set on low, the flame should be just slightly visible when viewed from the side. (See bottom figure at right.)

NOTE: Flame that is mostly yellow or golden in color is often due to foreign matter in the burner. You may need to clean your burners. See page 27 for instruction on removing and cleaning your burners.

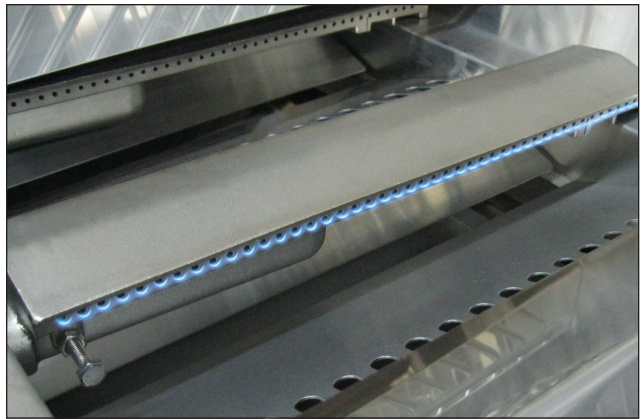

Gas Cylinder Orientation

LP gas cylinder must be up oriented upright during operation for proper vapor withdrawal. Operating the grill with the cylinder on its side will allow liquid gas to flow into the regulator. Erratic gas flow will occur, resulting in possible flare-ups or explosion.



Heat Distribution on the Cooking Grates

When you place food on your Cal Flame grill, remember that the back of the grill tends to be hotter than the front.

As your food cooks, you should periodically shift it to different spots on the cooking grates to ensure everything cooks evenly without burning.

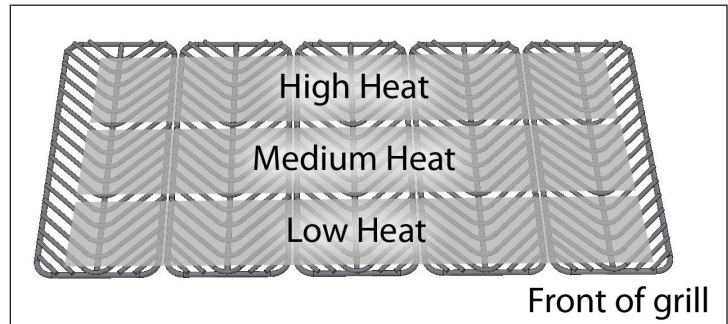

Convection Fan

A convection grill has an internal fan that circulates heated air evenly throughout the grilling area when the hood is closed. Cooking in this way distributes heat more efficiently so you no longer have to be concerned with "hot spots" on the grill where food tends to burn. The fan switch is located at the far left of the front panel of the grill.



Burner Knob Lights

The burner knob lights are LEDs located directly above each knob. Pressing the button on the right hand side of the grill powers up all of these lights simultaneously.

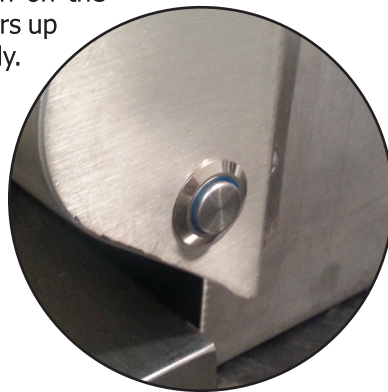

Using the Smoker Tray

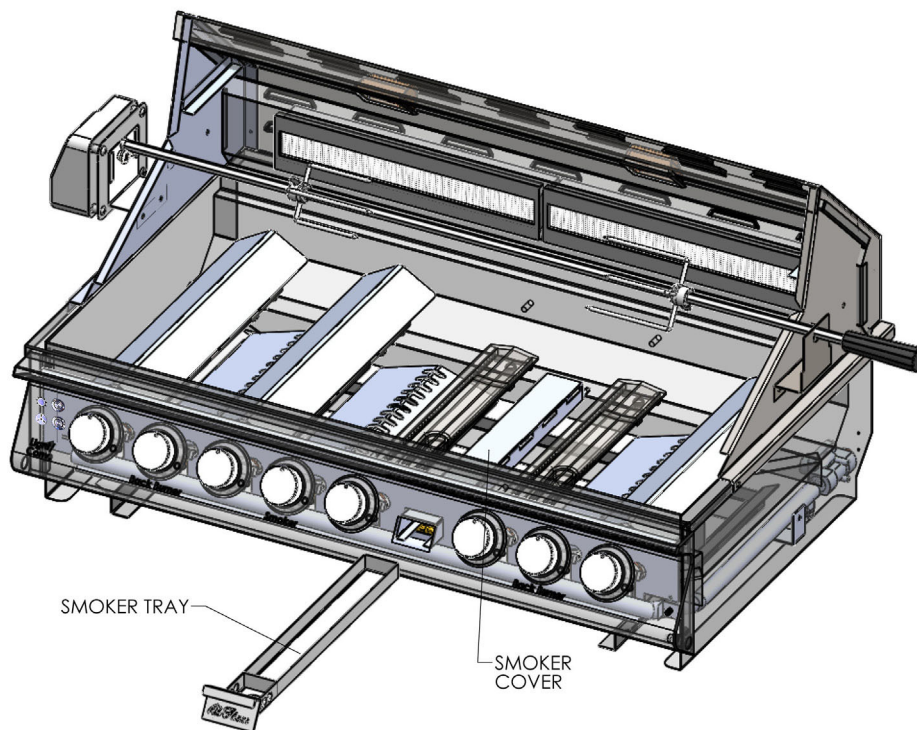

The Top Gun grill has a built-in smoker tray with a dedicated burner. Use the smoker tray to add a delicious smoky flavor to your grilled food.

The smoker tray slides out from a compartment in the front control area of the grill.

To use the smoker tray, begin by soaking wood chips in water for about 15 minutes. Drain the water and set them aside.

Pull the smoke tray out and set it on a counter top. Place wood chips in the tray and slide it back in.

Light the burner for the smoker tray, turn the heat up to HIGH, and let it burn for about five minutes or until it starts to produce smoke. When smoke appears,



turn the burner off, or else the wood chips will burn too quickly.

Ideally, the wood chips will smolder slowly for about 20 minutes. This is the best time to have food on the grill.

When the wood chips are burnt down to ash, you can empty the tray and refill it as many times as you wish while you grill.

After use, wait for the wood chips to extinguish and the grill to cool. Remove the smoker tray and dispose of the ashes. The smoker tray can be cleaned with soapy water. (See page 24 for care and cleaning of your grill.)



Cooking with the Rotisserie

The rotisserie cooks with the infrared back burner, which provides intense searing radiant heat. The location of the rotisserie and burner allows the placement of a rotisserie-basting pan (NOT included) beneath the food to collect juices and drippings for basting and gravy.

Before you can use the rotisserie, you need to mount the brackets and motor to the grill. See page 13 for instructions.

Loading food on the rotisserie rod

1. Hold the handle firmly while sliding one of the fork assemblies (prongs facing away from the handle) onto the rod.
2. Push the rod through the center of the food, then slide the other holder (prongs toward the food) onto the rod.
3. Center the meat (20 lbs maximum) on the rod and push the fork assemblies firmly together.
4. Tighten the thumbscrews.
5. To secure any loose portions of your meat, use butcher string (never use nylon or plastic string).
6. Place a basting pan under the food to collect the drippings.

Cooking with the rotisserie

1. Remove the warming rack.
2. Place the pointed end of the rotis rod into the motor and rest the threaded end on the support at the side of the grill. When the rod is pushed as far as possible into the motor, the grooved end of the rod should rest on the right side bracket.
3. If necessary, to offset unbalanced loads, slide the counter weight on to the rod. With the counter weight loose, allow the loaded rod to rotate and come to a stop. Now rotate the counter weight above the rod in a vertical position and tighten the thumbscrew. You can slide the counter weight away from or closer to the rotisserie rod as needed for balanced operation.
4. Light the infrared back burner. It will reach cooking temperature in about one minute. The orange/red glow will even out in about five minutes. The back burner flame can be adjusted to the level of intensity you prefer.



Plug in the rotisserie in any 110V outlet.



The rotisserie motor has an ON / OFF switch that controls the single-speed motor. The rotisserie rotates in both directions. You can change the direction by turning it off and turning it back on again.



Optional Grill Accessories

These grill accessories are optional and may be ordered in the following ways:

- Contact an authorized selling dealer
- Call LMS Customer Service at (800) 225-7727
- Visit us at www.quickbbqparts.com

Sear Zone Infrared Burner



BBQ07890P

The Sear Zone infrared burner can be use in place of any regular burner. Producing intense infrared heat, it cooks quickly with searing heat to seal in juices. (Note: The Sear Zone infrared burner is NOT the same as the infrared back burner used with the rotisserie.)

Instructions for installing the optional Sear Zone burner are on page 37.

Pizza Brick Tray



BBQ07900

You can use your grill as a pizza oven using the pizza brick tray. Made of stone and stainless steel, it fits on any Cal Flame grill and is large enough to cook a large sized pizza.

Set the tray on the grates, set the burners to medium heat, and heat up your grill for about 10 minutes. Place the pizza on the tray and close the hood. Depending on the size of the pizza, it will need between 10 to 20 minutes to cook.

Deep Fryer Helper Set



BBQ09902

The Deep Fryer Helper can turn part of your grill into a deep frying station. It is designed to fit in any Cal Flame grill.

The Deep Fryer Helper Set is shipped with its own instructions for placement and use. Read them carefully before use.

The Deep Fryer Helper Set comes with two commercial-sized fryer baskets, a built-in thermometer, and storage hangers allow baskets to be stored within unit. The lid closes and seals for easy storage—wet (with oil) or dry (drained). The lid can be removed for easy cleaning.

Charcoal Tray



BBQ11859

Turn part of your Cal Flame grill into a combination charcoal and gas grill.

Turn off the gas and wait for the grill to cool before setting the charcoal tray in place.

Placement

1. Remove two grates (left or right side) and the flame tamers (the angular metal pieces covering the burners). Do not remove the burners.
2. Set the charcoal tray in the grilling area so that the notches in the side rest on the round metal posts attached to the inside of the grill area. The charcoal tray will be resting over, but not ON, the burners.
3. Place the ash screen in the charcoal tray.

Using the Charcoal Tray

The Charcoal Tray is designed and intended to be used with plain charcoal. Quick-light charcoal can produce excessive heat and may be dangerous.

Make sure the drip tray is in the grill before you begin.

Keep the hood up until you are ready to cook.

1. Arrange charcoal in the tray.
2. Replace the grates.
3. Ignite both burners under the Charcoal Tray and turn them up to HIGH.
4. Let them burn until the charcoal remains lit without help from the burners. This should take 7 to 10 minutes.
5. When the charcoal is ready, turn off the burners.
6. Lower the hood if you wish to use the grill as a smoker.

Removal and Clean-up

When the grill has cooled and the charcoals are dead, clean the grill as described in the grill owner's manual.

Remove ash from the Charcoal Tray immediately after use. Do not let it accumulate. Do not use the grill again until charcoal ash has been removed from the Charcoal Tray and the drip tray.



Never use the Charcoal Tray over a Sear Zone infrared burner.



NEVER use charcoal in a gas grill without the charcoal tray. Doing so will void your warranty.

Rotisserie Basket



BBQ08892

Perfect for roasting vegetables or cooking fish, this rotisserie basket makes preparing these foods and others easy!

Open the rotisserie basket and set your food inside. Close and clamp it shut, then slide the rotisserie rod lengthwise through it. You can use it with either the standard burners or the infrared back burner.

Griddle Tray



BBQ07862P

The griddle tray is an optional feature installed in Cal Flame barbecue islands. Included with the griddle tray is an enclosure for storage.

When sliding the griddle out of the enclosure, always do it slowly as the heavy weight may cause you to suddenly drop the griddle. Lift the griddle out of the enclosure instead of sliding it all the way out.

Remove two cooking grates for the griddle space. Leave grease in the front drain when cooking. Wait until the griddle cools down when done cooking. Use both hands when removing the griddle and draining the grease.

Before storing the griddle, make sure it is clean and dry. Slide the griddle into the enclosure for safe and easy storage.

Pull-Out Cutting Board



BBQ07891P

The pull-out cutting board is an optional feature installed in Cal Flame barbecue islands.

The cutting board has an extra large cutting surface with a bacteria resistant surface. It is on a gliding mechanism that locks in full open position. A switch in the slider allows the cutting board to be removed for cleaning.

Cleaning and Maintenance

To ensure safe and proper maintenance, we recommend you follow these directions carefully.

Clean internal parts of the grill regularly as determined by the amount of use and foods cooked. The entire grill should be cleaned at least once a year.

In addition, keep the area around your grill clear and free from combustible materials, gasoline, and other flammable vapors and liquids. Do not obstruct the flow of combustion and ventilation air.

DISCONNECT ELECTRICAL SUPPLY BEFORE CLEANING ANY PART OF THE GRILL.

These instructions describe the best way to care for your stainless steel. They apply to grills and barbecue islands with stainless steel fixtures.

Although stainless steel grills will discolor and accumulate grime with regular use, they can keep their original shine with periodic cleaning. We strongly recommend using a surface protectant to prevent smudging and surface rust from accumulating.

The easiest way to clean the grill is immediately after cooking is completed. Doing so will extend the life of your grill, prevent grease fires, and present a pleasant appearance while you grill.

Stainless Steel Care and Cleaning

Baking soda, lemon oil, olive oil, vinegar, or club soda can also be effective for cleaning light soil on all stainless steel surfaces.

Do not use steel wool or wire brushes to scrub your grill.

For light soil, use a damp sponge or cloth.

For heavier stains, use a Scotch-Brite scrubber or similar product.

1. Clean

Thoroughly clean stains, food, and grime using a sponge or damp cloth with warm water and a mild dish soap. Use Fantastik or Formula 409 to remove heavier soil.

2. Rinse

Thoroughly rinse all surfaces and dry them completely with a clean towel. Do not allow stainless steel to air dry.

3. Polish

We strongly recommend that you apply a surface protectant to all exposed stainless steel surfaces.

Spray a small amount of WD-40 or Sheila Shine on a piece of paper towel and rub with the grain over the surface of the appliance. Using a clean terry cloth or paper towel, polish the appliance by rubbing with the

All exposed stainless steel surfaces require special attention if you want to keep them looking clean and bright. Following these simple instructions will help avoid scratching or damaging the finish and keep your stainless steel attractive.

Cleaning instructions for grill interiors, including racks and burners, are described after this section.

Cleaning Products and Materials

DO NOT USE these common cleaning products and materials – they will damage the surface of your stainless steel.

- CLR
- Lime-Away
- Oven cleaner
- Cleansers such as Ajax or Comet
- Ammonia
- Bleach
- Chlorine
- Steel wool pads
- Wire brushes
- Scrapers
- Pumice

We recommend these products for cleaning your stainless steel:

- Mild dish detergent such as Dawn
- Formula 409
- Fantastik
- Instant Rust Out (exterior ONLY)
- WD-40 (exterior ONLY)
- Sheila Shine (exterior ONLY)

We have had best success with Instant Rust Out, but WD-40 works very well too. Instant Rust Out is available in some hardware stores. WD-40 is widely available.

grain until excess liquid is removed and the surface shines. It should not be oily to the touch, however some residue is acceptable.

Furniture polish, such as Old English, can be effective for polishing stainless steel and protecting the surface.

 **Caution** Do not use Instant Rust Out, WD-40, or Sheila Shine near food or on food preparation surfaces as it is a health hazard. This includes the interior of the grill, grill racks, stainless steel sinks, the inside of cabinets, warming drawers, and ovens.

 **Fire Hazard** NEVER spray WD-40 or Sheila Shine near an open flame! These products are extremely flammable while in their aerosol forms.

Rust Removal

It is a common misconception that stainless steel does not rust. It does not stain, corrode, or rust as easily as ordinary steel (it *stains less*), but it is not stain-proof. If not properly protected and maintained, it can corrode, pit, and discolor.

 **Important** Because salt will accelerate rust and corrosion, grill or barbecue island owners who live near the beach need to be diligent in maintaining their stainless steel hardware. You need to clean and polish your stainless steel frequently, apply a protectant, and ensure water does not collect and puddle.

There are two methods of rust removal we recommend:

1. Rust removal with Instant Rust Out:

Spray exterior stainless steel surfaces with Instant Rust Out. Let it stand for about 30 seconds, then wipe with a clean cloth. Apply a second time if necessary.

Instant Rust Out will leave a white residue which can be rinsed off with water. Wipe the grill dry with a clean cloth and apply Sheila Shine or WD-40 as a surface protectant.

2. Rust removal with WD-40 or Sheila Shine:

Spray exterior stainless steel surfaces with WD-40 or Sheila Shine and wipe down with a dry cloth or paper towel until surface is free of rust. If there is significant rust or corrosion, use a Scotch-Brite scrubber.

Both of these products will act as a surface protectant and help resist smudges, stains, and rust.

 **Caution** Although nitric acid (also called aqua fortis) can be effective for rust removal, it is a highly corrosive chemical. Because of the potential for injury or damage to your stainless steel, we do not recommend using nitric acid.

Cleaning the Interior of Your Grill

1. Thoroughly clean stains, food, and grime using a sponge or damp cloth with warm water and a mild dish soap. Use Fantastik or Formula 409 to remove heavier soil.
2. Thoroughly rinse all surfaces and dry them completely with a clean towel. Do not allow water to accumulate and puddle on stainless steel. Water from various sources such as garden hoses contains iron which will give the appearance of rusting on stainless steel. If allowed to stand for long periods of time on stainless steel, it will cause pitting.
3. The racks, flame tamers, and flavor bars can all be removed for cleaning and are dishwasher safe.

Burners

Spiders and small insects occasionally inhabit or make nests in the burner tubes, obstructing the gas flow. Sometimes this results in a type of fire in and around the gas tubes called "flashback". To reduce the risk of flashback, this procedure should be followed at least once a month or when your grill has not been used for an extended period of time.

IMPORTANT: Prior to starting this procedure, turn OFF all of the gas control knobs, shut off the fuel supply, and disconnect the fuel line.

The burners can be removed by removing the locking pins and lifting them out. The locking pins

are located under the grill toward the back. They are used to keep the burners in place during shipping and are not necessary to operate your grill. Remove burners from the grill by carefully lifting each burner up and away from the gas valve orifice.

Use a wire brush to clean the outer surface of each burner to remove food residue and dirt. Clean any clogged ports with a stiff wire such as an opened paper clip.

Inspect each burner for damage (cracks and holes). If any damage is found, discontinue grill usage until you replace the burner.

Upon reinstallation, inspect the gas valve orifices for cleanliness and condition and the location of the igniters. When you replace the burners, you do not need to replace the locking pins.

Cooking Grates

Use a solution equal parts detergent and hot water just as you would for any cooking equipment. A stiff wire brush or steel wool may also be helpful in removing grime and food deposits.



Note

Do not use a wire brush or stainless steel on any other part of your grill or any other stainless steel surface except the cooking grates or the griddle!

Drip Pan

The full width drip pan will collect grease from the main grill area. The pan should be cleaned after every use to avoid the possibility of a grease fire. Be sure to allow the drip pan to cool prior to cleaning. You may clean the drip pan with a solution of warm soapy water. Make sure to rinse thoroughly to avoid staining.

Griddle

To prevent burns or injury, make sure the griddle is completely cool before cleaning.

The griddle is made from non-magnetic, 304 grade stainless steel. There are various stainless steel cleaners available. Always use the mildest cleaning procedure first, and always scrub in the direction of

the grain. Use soapy water for most cleaning. A non-abrasive scrubber may also be helpful in removing grime and food deposits. Steel wool may be used for especially difficult spots. Wipe all areas dry before storing.

Steam Cleaning Your Grill

Steam cleaning the interior of your grill is very effective and will not void your warranty. Portable hand-held steam cleaners are inexpensive and do not require chemicals. You can steam clean all parts of your Cal Flame grill, including the burners. When you are finished, make sure you wipe all surfaces down.

If you spray the burners, ignite them and let them burn for about 10 minutes to prevent any water from accumulating inside them.

Covering Your Grill

When not in use and after cooling, cover your grill with our full length, zippered side canvas cover. (See your local Cal Flame dealer for details.) The cover will help protect your grill from detrimental effects of weather and environmental pollutants. Never put a cover on a hot grill. Allow the grill to cool before covering.

Seasonal Cleaning

If you haven't used your grill in a few months, we recommend that you clean the burners and the interior of your grill. Cleaning the burners periodically will keep them burning evenly and cleanly and help prevent "flashback", a type of fire in and around the gas tubes. This happens when spiders and small insects inhabit or make nests in the burner tubes, obstructing the gas flow.

IMPORTANT: Before removing the burners, turn OFF all of the gas control knobs, shut off the fuel supply, and disconnect the fuel line.

1. Remove the components

Remove the racks, the flavor bars, and the flame tamers from the grill and set them aside. They don't need to be in the grill in order to clean them. In fact, all of the items can be cleaned in a dishwasher if you wish.

Leave the drip pan in place for now.

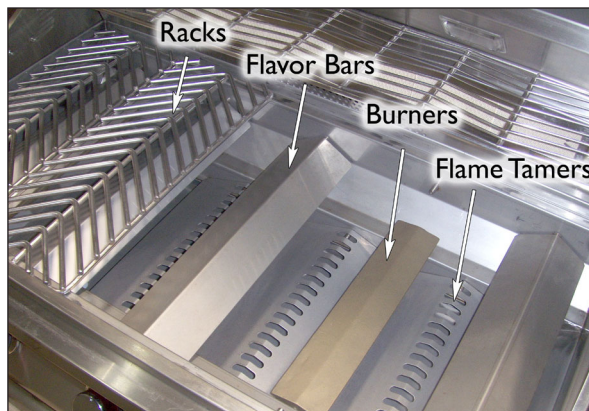

2. Remove the burners

The burners can be removed by taking out the locking pins and carefully lifting them up and away from the valve orifice. The locking pins are located under the grill toward the back. They are used to keep the burners in place during shipping and are not necessary to operate your grill.

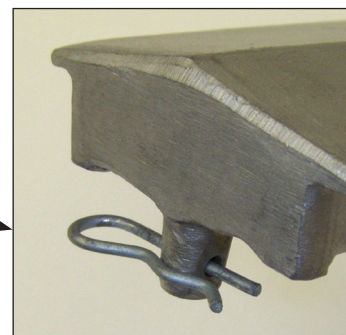
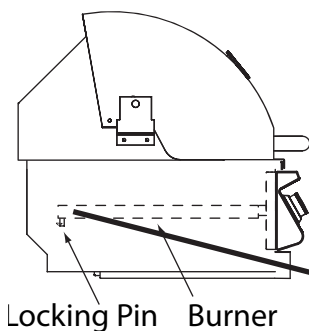

3. Clean the burners

Use a wire brush to clean the outer surface of each burner to remove food residue and dirt. Clean any clogged ports with a stiff wire such as an opened paper clip.

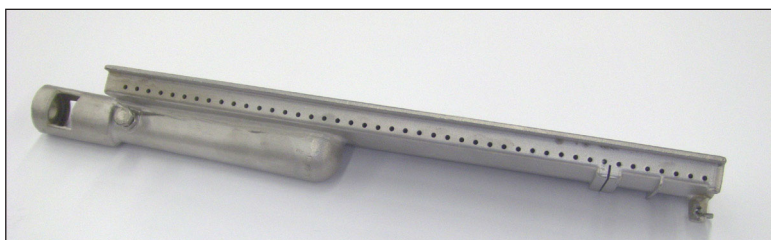

Make sure the flow channel is clear. The flow channel is the narrow slot on the bottom of the burner near the anchor post.

Inspect each burner for damage, such as cracks and holes. If any damage is found, don't use the grill until you replace the burner.

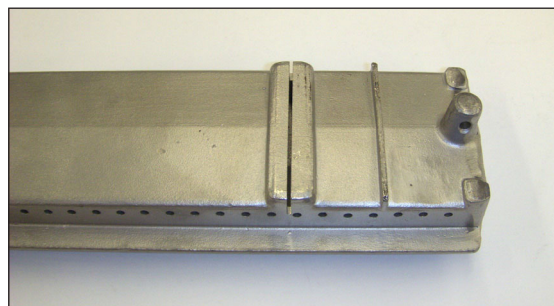

4. Clean the grill interior

While the burners are out of the grill, you can use this opportunity to clean the interior of your grill thoroughly. You should still have the drip pan in place to catch water and grime as you clean the grill interior.

When the grill interior is clean, remove the drip pan. Dump out any water and grime residue and spray it off with a garden hose.

Dry both the grill interior and the drip pan thoroughly to prevent water damage.

5. Clean the components

You can clean the racks by first soaking them in warm water and dish detergent and scrubbing them with a wire brush.

Clean the flavor bars and the flame tamers with dish detergent. You can use any kind of scrubber you wish: a non-abrasive pad, steel wool, or a wire brush, depending on your needs.

Dry all of the components thoroughly to prevent water damage.

6. Replace the burners

Before you replace the burners, inspect the gas valve orifices for cleanliness and condition and the location of the igniters.

Set the flame tamers in place before you replace the burners.

Carefully insert the burner into the opening for the valve orifice and gently slide it in. Then set the other end of the burner down so the anchor post rests in the hole.

When you replace the burners, you don't need to replace the locking pins.

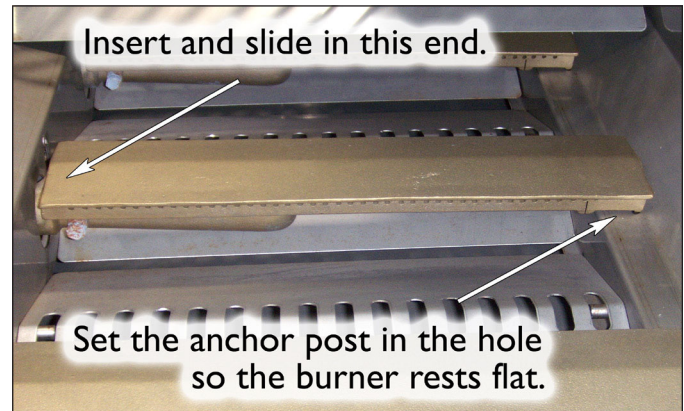

7. Replace the components

Put all of the components back as they were, as shown in step 1.

Light Bulb Replacement

WARNING: Never attempt to replace a light bulb when the grill is in use. Serious burns will result.

WARNING: Never touch halogen bulbs with your bare fingers. Use a tissue or a small piece of paper to handle bulbs. Oils from your hands will damage halogen bulbs.

Cal Flame grills use two different types of light housings. These instructions describe how to change the bulb in both types.

Light Lens with Screw Clip

1. Remove the screw at the left or right of the lens.
2. Carefully pull the lens away and out of the light fixture. Set the lens, screw clip, and screw aside.
3. Unscrew the two screws located at the side of the white ceramic light fixture.
4. Using a tissue or small piece of paper, pull the burnt bulb out of the socket.
5. Using a tissue or small piece of paper, carefully push a new bulb into the socket, making sure both wires on the bulb go into the light socket evenly.
6. Tighten the two screws on the side white ceramic light fixture.
7. Replace the light lens by replacing the screw and screw clip.

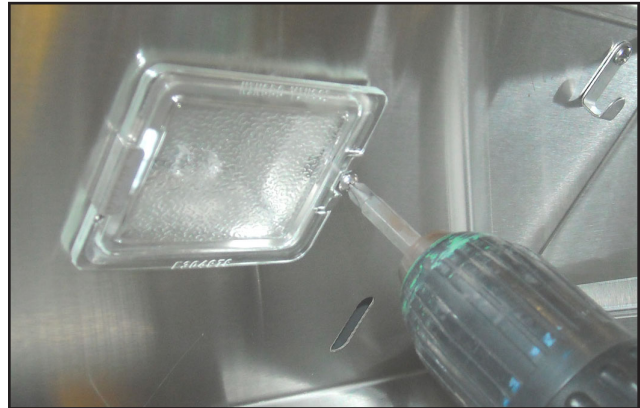

Snap-in Light Lens

1. Using a small standard screwdriver, carefully pop out the light lens and set it aside.
2. Using a tissue or small piece of paper, pull the burnt bulb out of the socket.
3. Using a tissue or small piece of paper, carefully push a new bulb into the socket, making sure both wires on the bulb go into the light socket evenly.
4. Replace the light lens by carefully snapping it back in place



Appendix

Troubleshooting

WARNING: Turn off the gas at the source while troubleshooting when it is required! Some steps require the gas to be shut off. Failure to follow these instructions carefully may result in personal injury.

Use the following procedure with the figure below.

Read this first before you begin troubleshooting.

Before you begin, familiarize yourself with the parts of the grill, how they work, and how to remove and replace them. Nearly everything inside the grill body can be removed for easy cleaning and maintenance. See "Seasonal Cleaning" on page 27 for more information.

In order for a burner to ignite, gas must be flowing through the burner, the igniter must produce a spark, and the igniter must be close enough to the gas to ignite it.

In the middle figure below, the burner has been removed to show the gas orifice. The burner tube slides in around the orifice.

The igniter needs to be properly aligned with the burner in order for the spark to ignite the gas. This is shown in the figure below at right.

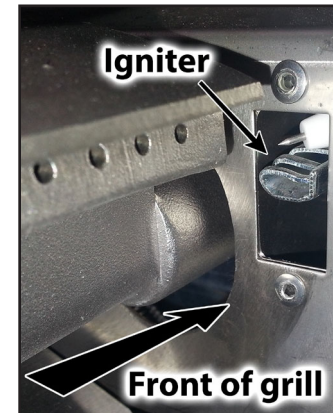
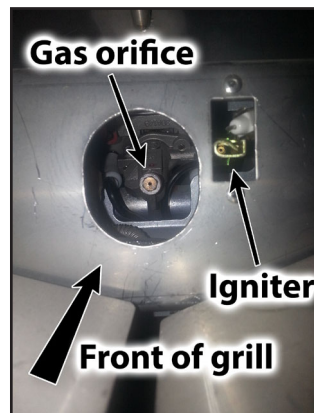
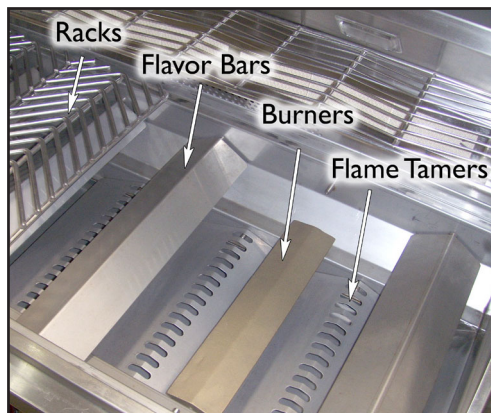

Grill has trouble lighting

None of the burners will light

If none of the burners will light, you may have an obstruction in the gas line. Disconnect the gas line from grill. Open the gas valve for one second to blow out any debris. Close off the gas valve and reconnect the fuel line securely. Let the area ventilate for a few seconds before reconnecting the fuel line.

One burner won't light

This describes troubleshooting a problem with a single burner and assumes you can light other burners, but one burner will not light. Beginning with the first step, make sure the gas is connected and all the source valves and open.

Step 1: Check gas flow.

Turn the gas knob on the front of the grill just enough for gas to flow and listen for gas. If you do not hear gas flow, the valve orifice may be blocked. Go to Step 4 to clean the valve orifice.

Step 2: Check the burner.

Remove the flavor bar before you perform this step.

Check obstruction in the burner tube. Sometimes the burner tube may be obstructed by dirt, dust, or spider webs. Remove the burner and check the tube for any debris. When it is clear, replace the burner.

Note: We recommend performing regular seasonal cleaning on your grill, which includes removing the burners and checking for debris, which can cause flashback and poor performance. See page 27 for seasonal cleaning instructions.

Check the burner alignment. The burner tube may be misaligned. Reposition the burner tube so that it is properly seated over the orifice.

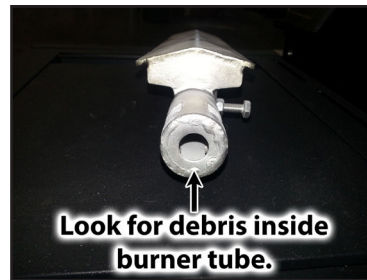

Step 3: Check the igniter.

For this step, you will need to shut off the gas at the source. Do not test the igniter while the gas is connected!

Check alignment of the igniter on the burner. Check for proper position of the electrode tip, which should be pointing forward towards the front of the burner and free of grease to allow proper sparking.

Check for spark. Look down into the grill and watch the igniter. Push the knob in fully and rotate it about 1/4 turn to the left (counter-clockwise) until you hear a loud click. You should see a blue spark at the electrode tip. If you do not, turn the knob back to the OFF position and try again. Repeat this several times to make sure igniter is functioning properly.



- If the igniter does not spark the first time but sparks subsequent times, it may be malfunctioning. Contact your Cal Flame dealer or Cal Flame customer support for assistance.
- If the igniter does not spark at all, it may need to be replaced. Contact your Cal Flame dealer or Cal Flame customer support for assistance.

Step 4: Check the valve orifice.

If you have done all of the steps above and the burner still will not light, the valve orifice may be blocked.

For this step, you will need to shut off the gas at the source. Do not remove the valve orifice while the gas is connected!

- Using a 10 mm socket, remove the orifice from the control valve.
- Gently clear any obstruction with a fine wire or a pipe cleaner.
- Reinstall the orifice and the burner.



After you clean and replace the valve orifice, return to Step 1 and check for gas flow.

If you still do not hear gas flow, you may have a problem with the gas valve itself. Contact your local Cal Flame dealer for assistance.

Smell of gas is present

Check for loose connections in the gas line. Perform a leak test following the procedure described in this manual.

If the smell is gas is still present, DO NOT USE THE GRILL. There may be a leak from a gas valve. Contact a gas appliance specialist for service.

Problem with gas flame

Wrong color

Once the entire burner is operating, check the flame color to be sure that it is mostly blue. Some yellow at the tips may be present due to impurities in the fuel. If the flame is golden or yellow in color, salts, oil film, or other foreign matter may be on the burner. This may indicate the burners need cleaning. See the section "Proper Burner Flame" in this manual for guidance on flame color and height.

Flame is too low or keeps going out

You may need to adjust the flame height if the flame goes out on the low setting. You can adjust the flame height and intensity according to your preferences. See the section "Proper Burner Flame" on page 17 for adjusting flame height.

Gas flame sputters

- Gas flame may be too low. Turn up the gas level, or adjust the flame height as described in the section "Proper Burner Flame" on page 17.
- There may be impurities in gas. Either change propane tanks with a second tank filled from a different source, or let the tank run out and refill it from another vendor.
- The burner is dirty. Clean the burner as described in the section "Seasonal Cleaning" on page 27.

Flashback

When fire occurs in and around the burner tubes, immediately turn off gas at its source and turn the control knobs clockwise to the 'OFF' position. Wait until the grill has cooled off and then clean the burner tubes and burners as described in the section "Seasonal Cleaning" on page 27.

Converting from LP to NG



WARNING! You must have an authorized service technician perform this procedure. If these instructions are not followed exactly, a fire or explosion may result causing property damage, personal injury or loss of life. Lloyd's Material Supply (LMS) will not be held responsible for an improperly converted gas grill.

All Cal Flame grills are manufactured as standard liquid propane (LP) grills and can be converted to burn natural gas (NG). There are two steps required to convert a grill from LP to NG.

You must perform both steps.

Step 1: Switching the regulator behind the grill

Step 2: Changing the burner orifices

The conversion kit provided with your grill may include **some or all** of the parts shown at right, depending on the size and model of your grill.

The kit contains orifices to convert main burners, rear infrared burners, and the large infrared burner. Your kit will have only the parts you need to convert your grill.

Before you begin, make certain the LP gas source has been disconnected from the grill.

To gain access to the NG regulator, tilt the grill forward.

Step 1: Switch the regulator behind the grill

The manifold in the image below has been removed from a grill to illustrate this procedure.

- Remove the LP gas line.
- Remove the cap fitting from the end of the NG gas regulator.
- Place the cap fitting over the LP gas inlet.
- Insert a male flared fitting (**not provided**) in the NG gas regulator.

Remove Cap Fitting

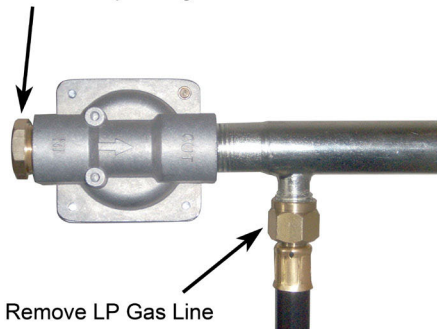

Remove LP Gas Line

Insert Flared Fitting in NG Regulator (Flared Fitting Not Provided)

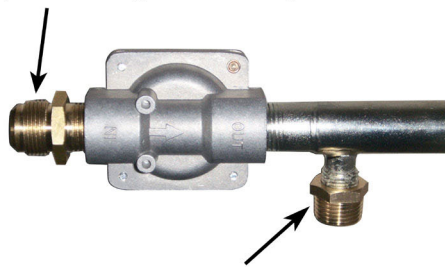

Place Cap Fitting on LP Inlet

MAIN BURNERS



1.9 mm male threaded
Quantity: 5

INFRARED BURNERS



#52 female threaded
Quantity: 2

SMOKER TRAY BURNER

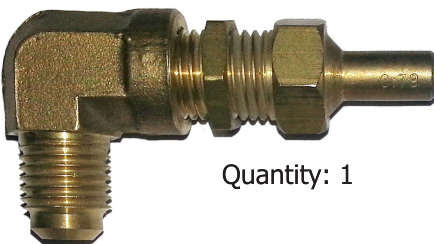

Quantity: 1

Note: Orifice size is marked on the top or side of the piece.

- You will need:
- Pipe wrench
 - Regulator
 - Pipe compound suitable for natural gas

Gas Conversion (continued)

Step 2: Changing the burner orifices

1. Replace the main burner orifices

- a. Remove the grates, flame tamers, and drip tray from the grill. See figure below.

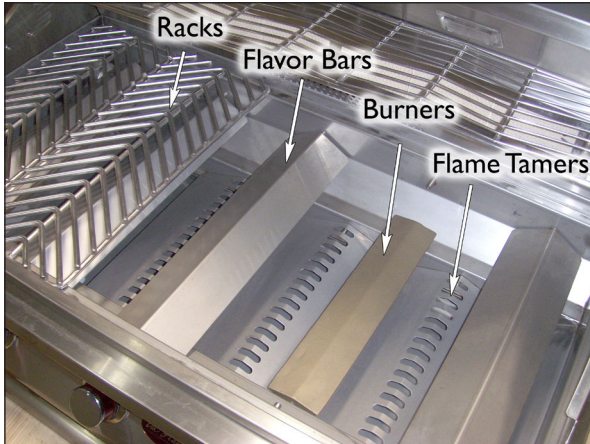

- b. The burners may still be locked in place with locking pins. They have to be removed before you can remove the burners.

The locking pins are accessible by removing the drip tray and tilting the grill back. They can be seen underneath the grill in the back. See figures below.

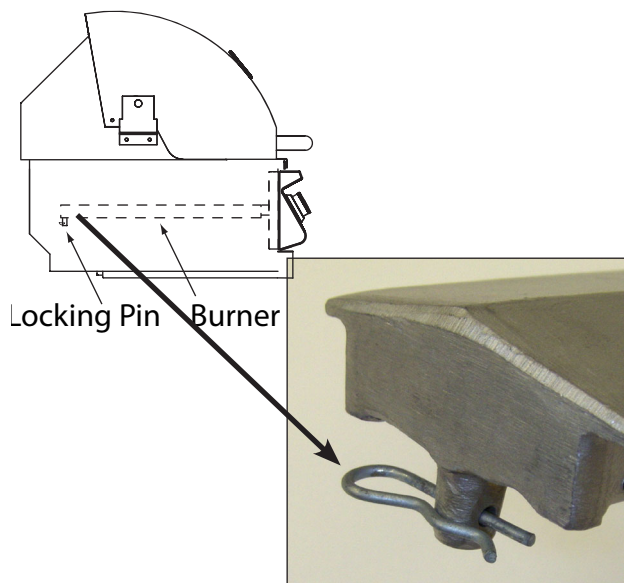

You will need:

- 6mm socket or nut driver
- Four or five 1.9mm orifices (depending on your grill)
- Pipe compound suitable for natural gas

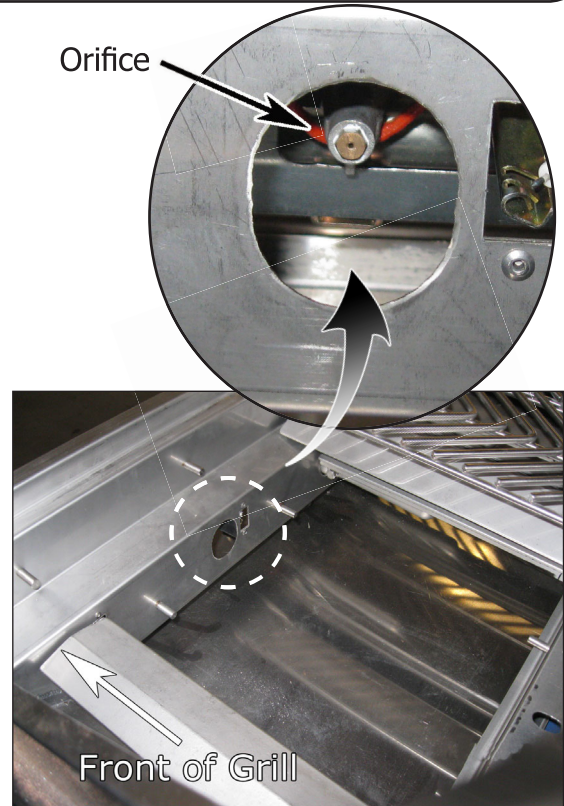

- c. Remove all burners by carefully lifting them up and away from the valve orifice.
- d. Using a 6mm socket or nut driver, remove the orifice for the burner.
- e. Apply a small amount of pipe compound to the orifice threads.
- f. Screw in the orifice until it is finger tight.
- g. Tighten the orifice with the 6mm wrench.
- h. Repeat the above steps for the remaining burners.
- i. Replace the burners, flame tamers, drip tray, and grates.

You do not need to replace the locking pins. They are used to keep the burners in place during shipping and are not necessary to operate your grill.

Gas Conversion (continued)

2. Replace the infrared burner orifices

You will need:

- Either a 13mm or 10mm open end wrench
- One #52 orifice (for single infrared burner)
OR
- Two #54 orifices (for dual infrared burners)
- Pipe compound suitable for natural gas

- Unscrew the back cover from the grill and lift it up and under the grill hood.



- Using a wrench, remove the orifice for the infrared burner.

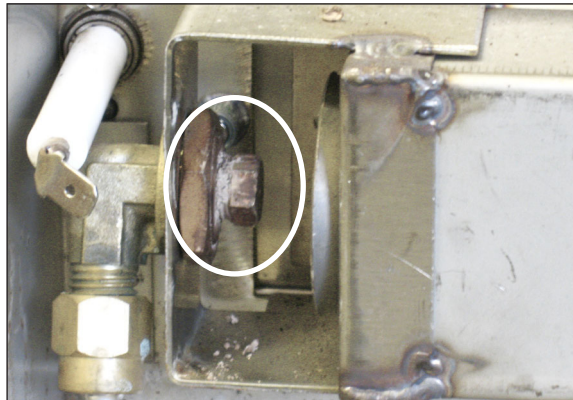

- Apply pipe compound to the fitting threads where you will place the new orifice.
- Screw on the correct orifice for your grill until it is finger tight.
- Tighten the orifice with the wrench.
- If you have dual infrared burners, repeat the previous steps for the second burner.
- Replace the back cover.

3. Replace the smoker tray burner orifice

4. Replace the side burner orifices

You will need:

- 7mm wrench, socket, or nut driver
- One or two 1.75mm orifices (depending on your side burner)
- Pipe compound suitable for natural gas

- Remove the grate, burner cap and burner diffuser from the side burner.

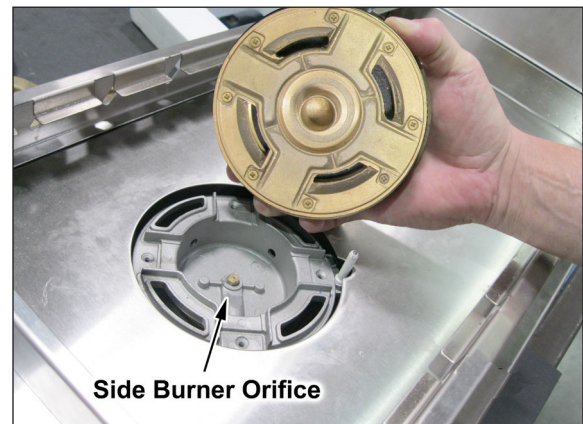

- Using a 7mm wrench, remove the orifice for the burner.
- Apply a small amount of pipe compound to the orifice threads.
- Screw in the orifice until it is finger tight.
- Tighten the orifice with the 7mm wrench.
- If you have dual side burners, repeat the previous steps for the second burner.

Gas Conversion (continued)

5. Mark the rating plate

After conversion has been completed, mark the rating plate as NG with an indelible marker.



Installing Sear Zone Burners

1. Disconnect or shut off the LP or natural gas line connected to the grill. Wait until the burners cool down.
2. Open the hood and remove the grate and flame tamer on top of the stainless steel burner you want to replace.
3. Through the access door underneath the grill, find the round stud and locking pin that locks the burner you want to replace.
4. Carefully remove the locking pin with your fingers.
5. Raise the stud from the locking hole and carefully move the burner forward to release it from the igniter and gas supply valve.
6. Take the burner out of the grill and store it in a safe and dry place.
7. Install the Sear Zone burner. Align the gas inlet on the burner with the gas supply valve on the grill and torch tube with the igniter. Make sure they align perfectly. Slide the stud at the other end into the locking hole.
8. Adjust the Sear Zone burner, make sure the burner is aligned and in position.
9. Repeat steps 2 through 9 if you want to replace other burners.
10. Put back the grate you just removed. (You don't need flame tamers for Sear Zone burners.)
11. Reconnect or turn on the gas line.

If you want to change Sear Zone burners to regular burners, just follow the above procedure above in a similar way.

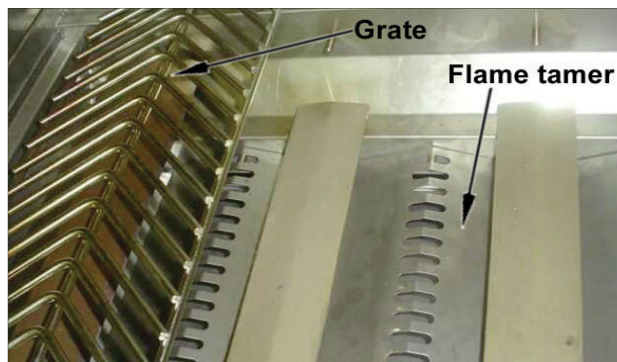

Replacement Parts

See following page for part numbers and ordering information.

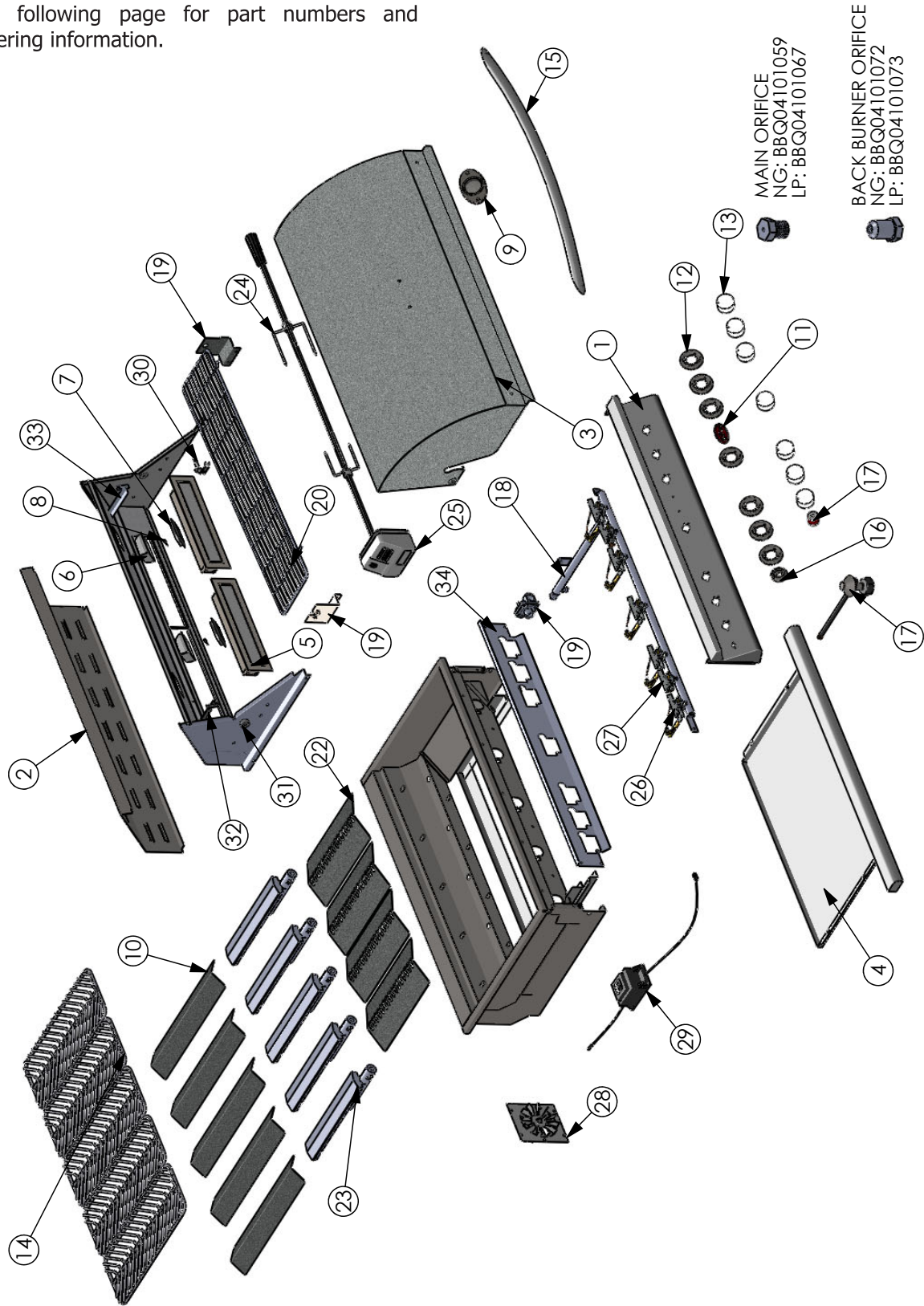

All parts can be used on all three grill sizes except where described below.

Item No.	Part	Grill Size	Part #
1	Control panel	3 burner	BBQ10104049-CC
		4 burner	BBQ07104050
		5 burner	BBQ10104051-CC
2	Back panel	3 burner	BBQ07104053
		4 burner	BBQ07104054
		5 burner	BBQ07104055
3	Hood	3 burner	BBQ07100587-CC
		4 burner	BBQ07100588-CC
		5 burner	BBQ07100589-CC
4	Drip pan	3 burner	BBQ07100686
		4 burner	BBQ07100687
		5 burner	BBQ07100688-CC
5	Back burner	3 and 4 burner	BBQ07300440
		5 burner	BBQ07300430
6	Light housing	All	BBQ10103070
7	Light lens	All	BBQ04103059
8	Halogen bulb	All	LIT16300031
9	Thermometer	All	BBQ07410350
10	Flavor bar	All	BBQ04103000
11	Cal Flame logo	All	BBQ04100972
12	Bezel	All	BBQ08410351
13	2" knob	All	BBQ04101028
14	Grates	All	BBQ04100659
15	Handle	3 burner	BBQ07100683
		4 burner	BBQ07100639
		5 burner	BBQ07100641
16	Light bezel	All	BBQ08410354
17	Light/fan knob	All	BBQ08101028
18	Manifold	3 burner	BBQ08000513
		4 burner	BBQ08000514
		5 burner	BBQ08000515
19	Regulator (LP)	All	BBQ04101043
	Regulator (NG)	All	BBQ04103040
20	Warming rack	3 burner	BBQ08100656-CC
		4 burner	BBQ01000657-CC
		5 burner	BBQ08100658
21	Rotisserie bracket	All	BBQ04100786
22	Flame tamer	All	BBQ04103010-CC
23	Burner	All	BBQ07100661

Item No.	Part	Grill Size	Part #
24	Spit rod assembly	3 burner	BBQ08856P3
		4 burner	BBQ08856P4
		5 burner	BBQ08856P5
25	Rotisserie motor	All	BBQ07100781
26	Main burner valve (LP)	All	BBQ04101016
	Main burner valve (NG)	All	BBQ04101015
27	Back burner valve (LP)	All	BBQ04101014
	Back burner valve (NG)	All	BBQ04101013
28	Convection fan	All	BBQ08000420
29	Transformer	All	BBQ07100781
30	Back burner electrode	All	BBQ04101809
31	Hood hinge	All	BBQ04101257
32	Upper rack holder, left side	All	BBQ04100706
33	Upper rack holder, right side	All	BBQ07100707
34	Convection panel heat shield	3 burner	BBQ07220172
		4 burner	BBQ07220170
		5 burner	BBQ07220171
	Grill cover (not shown in drawing)	All -- one size fits all	BBQC2345GB

To order replacement parts:

- Contact an authorized selling dealer
- Call LMS Customer Service at (800) 225-7727
- Visit us at www.quickbbqparts.com

LIMITED WARRANTY

This Limited Warranty is extended to the original purchaser of a Cal Flame Top Gun grill starting at time of delivery and installed for residential use in the United States and Canada.

Direct any warranty issue with your grill via email to customerservice@calflamebbq.com or phone (800) 225-7727.



10 Year Structure

Cal Flame grill structure or frame housing is warranted against rust-through, due to defects in material or workmanship in normal household use for ten years from the original date of purchase.



10 Year Stainless Steel Burners

Cal Flame Stainless Steel Burners are warranted against rust-through and operation failure, due to defects in material or workmanship in normal household use for ten years from the original date of purchase.



10 Year V-Grates

Cal Flame V-Grates are warranted against rust-through and operation failure, due to defects in material or workmanship in normal household use for ten years from the original date of purchase.



3 Year Flame Tamers and Warming Rack

Cal Flame tamers and warming rack are warranted against rust-through and operation failure, due to defects in material or workmanship in normal household use for three years from the original date of purchase.



1 Year Gas Valves and Other Components

Cal Flame gas valves and other components detailed in the Cal Flame grill owners manual, specifically on the Cal Flame parts list page, are warranted against operation failure due to defects in material or workmanship in normal household use for one year from the original date of purchase.

This Limited Warranty is void if Cal Flame (the "Manufacturer") or its designated representative determines that the grill has been subjected to damage or failure due to installation of aftermarket parts that are not genuine Cal Flame branded parts and accessories. This disclaimer includes, but is not limited to gas valves, gas nozzles, infrared burners, lights and transformers. Genuine Cal Flame brand parts and accessories are built to our highest standards of quality, durability and performance, and they are designed to work with your grill to ensure optimal performance and function.

Performance

In the event of a defect covered by this Limited Warranty, notify Cal Flame as soon as possible and use all reasonable means to protect the grill from further damage. Upon a receipt of a valid form of proof of purchase, a designated service representative will correct the defect, subject to the terms and conditions contained in this Limited Warranty. There will be no charge for parts, although providing access to affect the repair is your responsibility as the grill owner. Freight charges for replacement parts, labor and labor related trip charges necessary to repair the grill are

also the responsibility of the grill owner. In the event a replacement is offered, reasonable costs for removal of the original grill, shipping costs from the factory for the replacement grill and delivery and installation of the replacement will be your responsibility as the grill owner. Any replacement parts and or grill will carry the balance of the original grill warranty. Grill covers are not included. This warranty ends either by specified time frame listed above, owner-transfer, relocation, commercial installation or installation of any component other than by manufacturer.

Warranty Limitations

This Limited Warranty is void if Cal Flame or its designated representative determines that the grill has been subjected to alteration, neglect, misuse or abuse, or freight damage caused by the common carrier; any repairs or fuel conversion have been attempted by anyone other than a designated representative; or if the failure is caused by accident, acts of God or other causes beyond the control of the Manufacturer. Neglect, misuse and abuse include any installation, operation or maintenance of the grill other than in accordance with the instructions contained in the owner’s manual provided with the grill. Corrosion, scratching and discoloration due to improper use and care of this outdoor product, is excluded from this warranty.

Prorated Warranty

Units within the warranty timeframe determined by the Company to be non-repairable will be replaced on a prorated basis with the same or a comparable unit. The user will be charged one percent of the current retail cost for each full month of ownership from the date of purchase through the date failure is determined to be non-repairable. This charge will be waived during the first twelve months of ownership.

Limitations

The Manufacturer disclaims all warranties, expressed or implied, in fact or in law, to the extent allowed by your State’s Law, including the warranty of merchantability and fitness for use, except as stated specifically herein. All warranty service must be performed by the Manufacturer or its designated representative using authorized Cal Flame parts.

No agent, dealer, distributor, Service Company or other party is authorized to change, modify or extend the terms of this limited warranty in any manner whatsoever. The Manufacturer will not be responsible for any statements or representations made in any form that go beyond, are broader than, or are inconsistent with any authorized literature or specifications furnished by Cal Flame.

Disclaimers

The Manufacturer and its representatives shall not be liable for any injury, loss, cost or other damage, whether incidental or consequential, arising out of any defect covered by this limited warranty, including without limitation, loss of use of the grill and cost for removal of defective product even if the Manufacturer was advised of the possibility of damage. The liability of the Manufacturer under this limited warranty, if any, shall not exceed the original amount paid for the defective product. Coverage under this limited warranty shall commence as of the original date of purchase and the duration of such coverage shall not extend for any reason whatsoever beyond the stated time periods. These disclaimers shall be equally applicable to any service provided by the Manufacturer and its designated representatives.

Legal Rights

This Limited Warranty gives you specific legal rights. You may also have other rights that vary from state to state. Some states do not allow limitations on how long an implied warranty lasts, so this limitation may not apply to you.

Locating the product serial number

The serial number of your Cal Flame grill is located on the back and is visible when the hood is down. You will need this number to properly register your grill and activate coverage. Write this information in the space provided below.

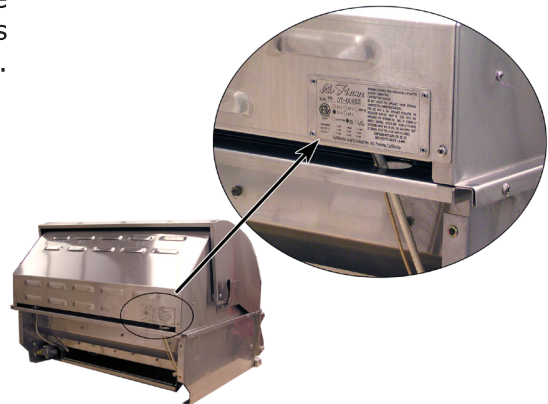

Grill model: _____

Grill serial number: _____

Type of fuel (circle one): Liquid propane Natural gas

Date purchased: _____

Date installed: _____

Cal Flame dealer's phone number: _____

Cal Flame dealer's address: _____

Don't forget to register your new product at www.calflamebbq.com.



WARNING! Proposition 65 Warning: Handling the brass material on this product exposes you to lead, a chemical known to the State of California to cause cancer, birth defects or other reproductive harm. (Wash hands after handling this product.)

This product and the fuels used to operate this product (propane or natural gas), and the products of combustion of such fuels, can expose you to chemicals including Benzene, which is known to the state of California to cause cancer and birth defects or reproductive harm.

For more information go to www.P65Warnings.ca.gov.